

The logo for trace storage features a stylized bar chart icon with three bars of varying heights in shades of blue and teal. To the right of the icon, the word "trace" is written in a lowercase, sans-serif font, and the word "storage" is written in a larger, lowercase, sans-serif font. Both words are in a light blue color.

trace storage

STORAGE PRICE BOOK

February, 2013

rev 03.17.2017

| Revision Levels | |
|-----------------|---|
| Date | Changes Made |
| 04.15.2014 | Added HW Lock, Removed Fabrics 7E Golden & 7L Deep Forest - Added 7T Butterscotch & 7V Sherwood |
| 11.12.2014 | Updated "Remit to" address in terms and conditions |
| 11.12.2014 | Page 25 - Recessed Front Laterals - "H" front now shows as available |
| 11.12.2014 | Page 26 - 12" Receding Door Lateral File with Roll-Out Shelves - "B" front now shows as not available |
| 11.12.2014 | Page 30 - under features, shelves are adjustable in 1-1/2", not 1/2" as previously stated |
| 11.12.2014 | Page 37 - Updated Trace Bookcase Depths & Widths to a more accurate representation of actual dimensions |
| 11.12.2014 | Page 37 - Updated Trace Bookcase Laminate Tops to a more accurate representation of actual dimensions |
| 11.21.2014 | Page 9 - Updated SL and ML locks |
| 02.04.2015 | Page 23 & 24 - B front is not available for FileCenters |
| 02.05.2015 | Page 35 Added additional shelves and updated Double Locker depths |
| 07.22.2015 | Page 21 Changed 1/4" overhang to 1/8" under Common Laminate Tops |
| 08.06.2015 | Pages 17, 19 & 20 added drawer height dimensions under laterals to clarify smaller space directly under lock strips |
| 08.06.2015 | Page 15 - Added Personal Drawer, removed plastic center drawer, removed Center Drawer |
| 08.26.2015 | Page 23 - Added Open shelf Lateral |
| 08.26.2015 | Page 5 - Corrected laminate thickness 1.25" |
| 08.26.2015 | Page 14 - Updated V-ped available fronts |
| 09.21.2015 | Page 23 - Updated ROSY102 price Open Shelf Lateral |
| 09.28.2015 | Page 2 - Updated fabrics |
| 10.12.2015 | Page 19 - Trace Counterweight sold separately updated bottom part number |
| 10.12.2015 | Page 3 - added statement about two-tone paint (Other PBs already have this) |
| 02.24.2016 | Page 9 - Lock Program page - updated the SL lock info as it does not have Master-Keys available |
| 04.19.2016 | Page 7 Added statement about fabric direction specification. |
| 04.19.2016 | Pages 11,12, 19 - Added bullet under cushioned products regarding cushion direction |
| 05.05.2016 | Added the supplemental Locker Price book (pages 35-40) |
| 05.20.2016 | Page 11 - updated statement, 1-1/2" cushions are factory installed with screws |
| 05.26.2016 | Page 21 & 27 - added weights and cubes |
| 06.22.2016 | Page 11 - Added statement about weight limit for Cushion Mobile Peds |
| 06.29.2016 | Page 12 & 23 - Updated available fronts |
| 07.08.2016 | Page 2 & 3 added Dwelling Colors |
| 08.31.2016 | Page 21 & 27 Corrected widths on common tops to be 1/4" |
| 10.06.2016 | Page 21 Corrected Depths to 1/2" and 36-3/4", Page 2 & 4 removed "Beige Nebula" from laminate choices |
| 10.11.2016 | Page 8 - Updated statement about lead time for COM fabrics. |
| 11.02.2016 | Page 15 - Corrected Personal Drawer with Lock part number |
| 11.02.2016 | Multiple pages - Removed embossed label option - a different option will be added shortly |
| 01.01.2017 | Updated ped prices with new 8% price drop, updated laminate information on page 2 |
| 01.04.2017 | Updated the terms and conditions, minor changes on locker common tops |
| 01.10.2017 | Changed single door locker statement about top shelf to adjustable shelf (was fixed) |
| 01.12.2017 | Page 35 - added Multi-color door fronts option for lockers |
| 01.13.2017 | Page 7 - updated Fabrics |
| 01.17.2017 | Page 46 - fixed error in the single wide cubby (had # of doors labeled incorrectly for the 4 door single wide cubby) |
| 01.18.2017 | Pages 38 & 44 - corrected 18"w x 24"d double locker part number |
| 01.31.2017 | Page 17 - Corrected dimensions of Personal Drawer |
| 02.10.2017 | Added statement about page 8 yardage requirements next to corresponding products, removed the GO cart |
| 02.17.2017 | Page 14 - Corrected Lester price table, Locker section - 12" & 18" lockers - updated bullet points |
| 02.23.2017 | Page 14 - Added available fronts |
| 02.28.2017 | Page 18 - Updated info on Inner Drawer dimensions, page 21 - clarified bullet point info below 6" drawer lateral files, |
| 03.09.2017 | Page 15 - Corrected Molly Line art |
| 03.17.2017 | Page 14-15 - updated Chester & Lester verbiage and page layouts, updated commercial terms and conditions, removed the freestanding Cushion Filecenter |



| | Page |
|---|-------------|
| Specification Guide | |
| Quick Reference for Ordering | 2 |
| Paint Program | 3 |
| Laminate Program | 4 |
| Specialty Fronts | 5 |
| Laminate, Edge Band Specifications | 6 |
| Fabric Program | 7 |
| Ordering COM Fabrics | 8 |
| Lock Program | 9 |
| | |
| Trace Pedestal Files | |
| Pedestal FAQs | 10 |
| Pedestal Files | 11 |
| Personal Drawer | 15 |
| Pedestal File Accessories | 16 |
| | |
| Trace Lateral Files | |
| Lateral File FAQs | 17 |
| Trace Lateral Files | 18 |
| Recessed Front Lateral Files | 25 |
| Lateral File Accessories | 28 |
| | |
| Trace Towers | |
| Tower FAQs | 30 |
| Towers | 31 |
| | |
| Trace Lockers | |
| Locker Features and Options | 35 |
| Locker FAQ's | 36 |
| Lockers with Keyed Locks | 38 |
| Electronic Locks FAQs | 43 |
| Lockers with Electronic Locks | 44 |
| | |
| Trace Storage Cabinets and Bookcases | |
| Double Door Storage Cabinets | 50 |
| Bookcases | 51 |
| | |
| Terms and Conditions | |
| Commercial | 52 |
| GSA | 54 |

TRACE Storage Price Book

February, 2013

[rev 03.17.2017](#)

Great Openings
902 E. 4th Street
Ludington, MI 49431

Customer Service:
Phone: 888-712-8582
Fax: 231-843-6373
goorders@greatopenings.com

www.greatopenings.com
Printed Literature: www.goliterature.com

QUICK REFERENCE FOR ORDERING

SEE PAGE 2 FOR COLORS, LAMINATES, FABRICS

All drawer fronts are not available on all products. For restrictions see the individual product pages.



A: Full Pull



Q: Square, Satin Nickel Bar Pull



S: Square, Satin Nickel Loop Pull
(Add "B" suffix for black pull)



Y: Square, Black Wire Pull



B: S-9000 Pull



F: Square, Recessed Pull



H: Square, HW Pull



P: Square, P Pull



D: Radiused, Recessed Pull



I: Radiused, HW Pull



N: Radiused, Satin Nickel Loop Pull
(Add "B" suffix for black pull)

P: Square Front "P" Pull Colors:

- 0159 Beige
- 0006 Charcoal
- 0547 Graphite
- 0131 Smoke

Products ordered in any other color will include 0006 Charcoal pulls

D: and F: Recessed Pull Colors:

- 0256 Black Umber
 - 0257 Light Grey
 - 0004 Medium Tone
- Products ordered in any other color will include 0256 Black Umber pulls

PAINT FINISHES

Great Openings Standard Colors

| Allsteel | Haworth |
|-------------------------------|----------------------------|
| 0217 Brilliant White | 0159 Beige |
| 01A7 Champagne Metallic | 0228 Cement Textured |
| 0073 Cloud | 0141 Chalk |
| 0232 Driftwood | 0006 Charcoal |
| 0231 Flint | 0547 Graphite |
| 0536 Loft | 0205 Greystone |
| 0683 Muslin | 0229 Grout Textured |
| 0345 Parchment | 0112 Putty |
| 0166 Platinum Metallic | 02Y9 Silver Metallic |
| 0239 Fossil | 0131 Smoke |
| Herman Miller | Knoll |
| 0256 Black Umber | 0968 Beige Mist Metallic |
| 0257 Light Grey | 0222 Bright White Smooth |
| 0004 Medium Tone | 02Z3 Bright White Textured |
| 0001 Dark Tone | 02Y7 Brown |
| 0744 Metallic Champagne | 0623 Folkstone Grey |
| 0666 Silver Metallic | 0188 Medium Grey |
| 02L6 Soft White | 02Y6 Medium Metallic Grey |
| 0784 Warm Grey Neutral | 0756 Sandstone |
| 03C6 White Textured Enhanced | 02X9 Silver Metallic |
| 0348 Innertone Light | 0030 Soft Grey |
| Steelcase | Teknion |
| 0995 Arctic White Textured | 02M0 Arctic Textured |
| 0668 Black Textured | 02X5 Espresso Textured |
| 0044 Black | 02M3 Granite |
| 0998 Carbon Metallic Textured | 02A3 Grey |
| 0678 Fieldstone Textured | 02U2 Latte Textured |
| 0722 Midnight Textured | 02M2 Nevada |
| 02A4 Milk | 02X7 Platinum Metallic |
| 0666 Platinum Metallic | 02Z0 Satin Black |
| 0705 Sterling Metallic | 02X4 Silver Textured |
| 0280 Warm White | 02N0 Storm White Textured |

Dwelling Color Palette

| | |
|-----------------------|------------------|
| 03Q9 Special Gray | 03Q4 Jonquil |
| 03Q7 Bracing Blue | 03P8 Garden Sage |
| 03Q8 Honest Blue | 03Q5 Emberglow |
| 03Q0 Retreat | 03Q3 Chamois |
| 03Q1 Rivenway | 03Q3 Brandywine |
| 03P9 Independent Gold | 03Q2 Antique Red |

HIGH PRESSURE LAMINATES (HPL)

| GO Part # | HPL Laminate | PVC Trim |
|-----------|------------------|------------------|
| DWDW | Designer White | Designer White |
| BKBK | Black | Black |
| FGFG | Fashion Grey | Fashion Grey |
| SGSG | Shadow | Shadow |
| DMGH | Slate Grey | Slate Grey |
| DZDZ | Desert Zephyr | Desert Zephyr |
| SLSL | Steel Mesh | Steel Mesh |
| GYGY | Grey Mesh | Grey Mesh |
| B4B4 | Bleached Legno | Bleached Legno |
| NNNN | Neutral Twill | Neutral Twill |
| S8S8 | Sarum Twill | Sarum Twill |
| BGBG | Brighton Walnut | Brighton Walnut |
| RHRH | River Cherry | River Cherry |
| BCBC | Biltmore Cherry | Biltmore Cherry |
| WCWC | Wild Cherry | Wild Cherry |
| KMKM | Kensington Maple | Kensington Maple |

THERMAL FUSED LAMINATES (TFL)

| GO Part # | TFL Laminate | PVC Trim |
|-----------|------------------|------------------|
| M-FGFG | Fashion Grey | Fashion Grey |
| M-WCWC | Wild Cherry | Wild Cherry |
| M-KMKM | Kensington Maple | Kensington Maple |

FABRICS

| GO Part # | Color Name |
|-----------|--------------|
| 7A | Black |
| 8Q | Azure |
| 7C | Nickel |
| 7J | Steel |
| 7K | Navy |
| 8R | Red Red Wine |
| 7B | Grey |
| 7G | Fire |
| D1 | Aubergine |
| 7D | Jodhpurs |
| D2 | Lake |
| 8M | Cocoa |
| 8P | Zen |
| 8S | Brick |
| 8L | Galaxy |

All Great Openings products are finished with a hybrid powder formula (epoxy and polyester), which ensures an exceptionally durable, consistent finish. Simply select from our 72 Standard Colors, Industry Favorites (viewed online), or Custom Colors.

72 Standard Colors

All at standard lead times and price, standard colors are smooth, except those identified as textured.

Allsteel

0217 Brilliant White
01A7 Champagne Metallic
0073 Cloud
0232 Driftwood
0231 Flint
0536 Loft
0683 Muslin
0345 Parchment
0166 Platinum Metallic
0239 Fossil

Herman Miller

0256 Black Umber
0257 Light Grey
0004 Medium Tone
0001 Dark Tone
0744 Metallic Champagne
0666 Silver Metallic
02L6 Soft White
0784 Warm Grey Neutral
03C6 White Textured Enhanced
0348 Innertone Light

Steelcase

0995 Arctic White Textured
0668 Black Textured
0044 Black
0998 Carbon Metallic Textured
0678 Fieldstone Textured
0722 Midnight Textured
02A4 Milk
0666 Platinum Metallic
0705 Sterling Metallic
0280 Warm White

Haworth

0159 Beige
02Z8 Cement Textured
0141 Chalk
0006 Charcoal
0547 Graphite
0205 Greytone
02Z9 Grout Textured
0112 Putty
2Y9P Silver Metallic
0131 Smoke

Knoll

0968 Beige Mist Metallic
02Z2 Bright White Smooth
02Z3 Bright White Textured
02Y7 Brown
0623 Folkstone Grey
0188 Medium Grey
02Y6 Medium Metallic Grey
0756 Sandstone
02X9 Silver Metallic
0030 Soft Grey

Teknion

02M0 Arctic Textured
02X5 Espresso Textured
02M3 Granite
02A3 Grey
02U2 Latte Textured
02M2 Nevada
02X7 Platinum Metallic
02Z0 Satin Black
02X4 Silver Textured
02N0 Storm White Textured

Dwelling Color Palette

03Q9 Special Gray
03Q7 Bracing Blue
03Q8 Honest Blue
03Q0 Retreat
03Q1 Riverway
03P9 Independent Gold
03Q4 Jonquil
03P8 Garden Sage
03Q5 Emberglow
03Q3 Chamois
03Q3 Brandywine
03Q2 Antique Red

Industry Favorites (viewed online)

Visit www.greatopenings.com to find a comprehensive list of colors that are available for you to order just as though they were among our 60 Standard Colors.

- No added cost
- Standard lead-time
- No minimum order size
- Not necessary to exchange paint chip samples or to get your signed approval, as we already know we have a good match with the original manufacturer's color
- Simply send us your purchase order with the paint color name and number identified in this online list

- Great Openings will process your order, then send you an order acknowledgement
- Depending on paint cost and availability that is beyond our control, colors may be added or removed from this list of Industry Favorites

Please understand that color match is not a perfect science. While Great Openings uses the most sophisticated powder formula color match technology available, our greatest challenge remains the fact that the major manufacturers' colors tend to "drift" over time. Bright whites and silver metallics, in particular, are a challenge to match. For all practical purposes, in common artificial light as well as natural light, Great Openings' Industry Favorites will be an excellent match for our competitors' colors.

Custom Colors

When you need a color that's not included in our 60 Standard Colors or Industry Favorites, simply send us a paint chip and we'll get it matched. A special lead time or cost will likely be included, but we can almost certainly supply exactly the color you need.

- No minimum order size on Custom Colors
- Custom Color up-charge is applied on a per unit basis
- Minimum lead-time is 15 working days after we receive your written color approval
- We must receive a purchase order before exchanging custom color samples.

Check our website for Custom Designer Colors, a sampling of trending new custom colors!

Here's how it works for custom colors:

1. Along with your purchase order, send us a 2" X 2" sample of your desired Custom Color (a metal chip is best, but often a laminate or paper sample will work).
2. We'll work with our paint suppliers to find a match, a process that typically takes 10 to 15 business days. Then we'll send a metal sample of our recommended paint color back to you, along with a sign-off sheet, total net up-charge, and lead-time requirements.
3. You'll return the sign-off sheet, we'll send you an order acknowledgement, and away we go!

Two-tone cabinets, with fronts painted a different color than the cabinet are available. Contact Sales for a quote.

Please note: Our objective is to order exactly the correct amount of paint for each order so that we can offer you the lowest possible price. For this reason, if you happen to order the same custom color again weeks, months, or years later, paint inventory will likely not exist and any additional costs will once again be charged per unit, no matter the order size.

LAMINATE PROGRAM

SEE PAGE 2 FOR COLORS, LAMINATES, FABRICS

Standard Laminates

Great Openings offers 16 standard HPL laminates and 3 standard TFL (thermal fused) laminates, all at standard price and lead time.

| GO Part # | Laminate | Cross Reference Wilsonart® | 3mm PVC Trim |
|-----------|------------------|-------------------------------|------------------|
| DWDW | Designer White | D354-60 | Designer White |
| BKBK | Black | 1595-60 | Black |
| FGFG | Fashion Grey | 381-60 | Fashion Grey |
| SGSG | Shadow | D96-60 | Shadow |
| DMGH | Slate Grey | D91-60 | Slate Grey |
| DZDZ | Desert Zephyr | 4841-60 | Desert Zephyr |
| SLSL | Steel Mesh | 4879-38 | Steel Mesh |
| GYGY | Grey Mesh | 4877-38 | Grey Mesh |
| B4B4 | Bleached Legno | 8845-58 | Bleached Legno |
| NNNN | Neutral Twill | 8826-58 | Neutral Twill |
| S8S8 | Sarum Twill | 8827-58 | Sarum Twill |
| BGBG | Brighton Walnut | 7922K-07 | Brighton Walnut |
| RHRH | River Cherry | 7937-38 | River Cherry |
| BCBC | Biltmore Cherry | 7924K-07 | Biltmore Cherry |
| WCWC | Wild Cherry | 7054-60 | Wild Cherry |
| KMKM | Kensington Maple | 10776-60 | Kensington Maple |

THERMAL FUSED LAMINATES (TFL)

| GO Part # | TFL Laminate | PVC Trim |
|-----------|------------------|------------------|
| M-FGFG | Fashion Grey | Fashion Grey |
| M-WCWC | Wild Cherry | Wild Cherry |
| M-KMKM | Kensington Maple | Kensington Maple |

Industry Favorite Laminates

Additionally, find our Industry Favorite Laminates at greatopenings.com. This is a living document, updated periodically to include certain additional laminates currently available at a standard cost and lead time

Custom Laminates (including veneers)

When you need a laminate or edge band that's not included in our Standard or Industry Favorite Laminates, call Great Openings to request a special quote and lead-time. We have access to WilsonArt®, Formica®, Nevamar®, Pionite® and many more.

Please note that custom laminates or edges will require additional charges, lead-time, and minimum order quantities.

When it's time to place your custom laminate order, include the following information on your PO:

- name of your laminate and edge
- manufacturer names
- pattern names
- identification numbers

Custom laminates and edges cannot be changed or cancelled after the order has been confirmed by our Customer Service Department and an order acknowledgement has been sent.

Standard Work Surface Specifications:

Specifications for (HPL) high pressure laminate work surfaces, cabinet tops, and drawer fronts:

- Industrial grade particleboard, single-sided decorative laminate overlay
- High performance, high pressure laminate backer
- California Air Regulation Board Compliant to Phase 2. FSC Controlled Wood Status
- Water based, formaldehyde free, GREENGARD (registered sign) certified adhesive
- Finished thickness of horizontal application work surfaces is 1.25"
- Finished thickness of vertical application drawer fronts and doors is .75"
- Edge bands are 2mm or 3mm

Specifications for (HPL) high pressure doors:

- Identical to the specification shown above, except doors feature two-sided decorative high pressure laminate, so the appearance is identical inside and out.

Specifications for (TFL) thermal fused laminates for drawer fronts and doors:





- TFL is a cost effective, durable product used on vertical services such as drawer fronts and doors. The laminate paper itself is identical to three of the laminates shown above and so can be matched with work surfaces.
- TFL offers the same abrasion resistance as High Pressure Laminate and slightly less impact resistance, therefore it's appropriate for use on drawer fronts and doors. Thermal Fused Laminates do not meet NEMA specification requirements, scratch resistance, or ball drop tests.
- Two-sided decorative high pressure laminate, so the appearance is identical inside and out.
- California Air Regulation Board Compliant to Phase 2. FSC Controlled Wood Status
- Finished thickness of TFL drawer fronts and doors is .75"
- Edge bands are 2mm or 3mm (identical to those used on HPL fronts)

SPECIALTY FRONTS AND OPTIONS

SEE PAGE 2 FOR COLORS, LAMINATES, FABRICS

Products Available with Laminate Fronts

Any of the following Great Openings cabinets may be special-ordered to include factory-installed laminate fronts. Laminates may be one of Great Openings' standards, or a special ordered laminate. Laminate wood grain is positioned vertically on all fronts, including tower doors. Laminate fronts must be specified to include any one of our loop pulls. UM Series locks are included as standard. Please call Sales for a quote.

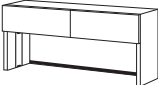
| | Notes | Product |
|---|---|--|
|  | Cayenne drawer fronts are full width, and the lock is located in the bottom drawer. | Cayenne two drawer cabinet (any width) |
|  | Pedestal drawer fronts and lock strip will be laminate. Cushion pedestals will not include a loop pull on the lock strip. Not available on 3" pencil drawers. | box/file pedestal file/file pedestal box/box/file pedestal |
|  | Lateral drawer fronts and lock strip will be laminate. | Trace box/file lateral (any width) Trace 2-high lateral (any width) Trace 3-high lateral (any width) Trace 4-high lateral (any width) Trace 5-high lateral (any width) Trace 6-high lateral (any width) |
|  | Laminate drawer and door fronts are full-width. The tower top and base are both visible from the front of the cabinet, and will be metal. | Cupboard wardrobe tower (any height) |
|  | Hutch doors are full width, and do not include loop pulls. Locks are concealed below the shelf. | Trace desk hutch doors (any width) |

Additional mixed material front options

Most of Great Openings cabinets may also be ordered with special veneer fronts. Please contact the GO Sales Team for a quote.

Digital lock options

Many of Great Openings cabinets may also be ordered with individually keyed digital locks. Please contact the GO Sales Team for a quote.

Custom Products

Towers and lockers specially-designed with a custom height, width, or depth may be available for sufficient quantities.

Fabrics:

Great Openings has graded programs with C.F. Stinson and Maharam, and fabric swatches may be ordered directly from them. Please check greatopenings.com for our current fabrics and grades.

For your convenience, we display fifteen C.F. Stinson New Hempstead fabrics in our finish card and price book, just to make it simple to pick a low texture, solid color, 100% polyester fabric. All of these “standard” fabrics are priced at GRADE 1.

| GO Part # | Fabric | C.F. Stinson |
|-----------|--------------|-----------------------|
| 7A | Black | NH333 - New Hempstead |
| 8Q | Azure | NH359 - New Hempstead |
| 7C | Nickel | NH361 - New Hempstead |
| 7J | Steel | NH366 - New Hempstead |
| 7K | Navy | NH369 - New Hempstead |
| 8R | Red Red Wine | NH389 - New Hempstead |
| 7B | Grey | NH395 - New Hempstead |
| 7G | Fire | NH406 - New Hempstead |
| D1 | Aubergine | NH419 - New Hempstead |
| 7D | Jodhpurs | NH420 - New Hempstead |
| D2 | Lake | NH423 - New Hempstead |
| 8M | Cocoa | NH424 - New Hempstead |
| 8P | Zen | NH425 - New Hempstead |
| 8S | Brick | NH434 - New Hempstead |
| 8L | Galaxy | NH509 - New Hempstead |

For memo samples, contact C.F. Stinson at 800-841-6279 or see www.cfstinson.com.

Fabric Specifications:

- Contents..... 100% polyester
- Finish..... Soil and stain protective finish
- Abrasion Resistance (astm d-4157)..... Exceeds 100,000 (Bryant Park), and 800,000 (New Hempstead) double rubs (heavy duty Wyzenbeek Method)
- Color Fastness - Light (aatcc-16)..... 40 hours class 4 minutes (New Hempstead), and 5 minutes (Bryant Park)
- Crocking (aatcc-8)..... (dry) class 4.5 minutes (wet) class 4.5 minutes
- Flammability:
- Calif. 191-53 Tech. Bulletin 117, Section E..... Passes
- UFAC and BIFMA..... Class 1
- Cleaning (w-s)..... Professional service is recommended or use water-based agents

Unless otherwise specified, the fabric grain on all cushions will be applied "front-to-back" as shown below.

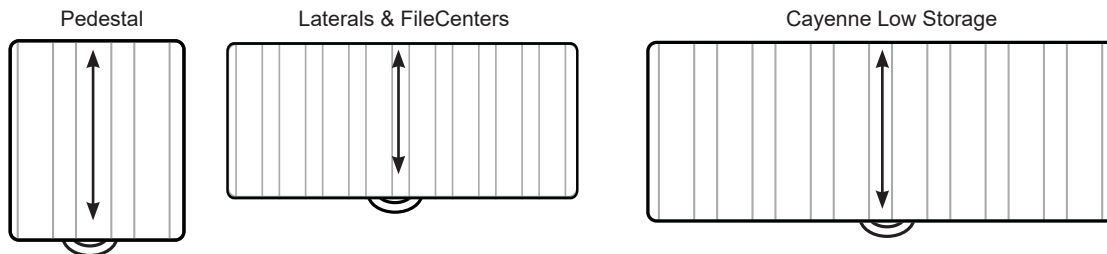

ORDERING COM FABRICS

HOW TO SPECIFY COM FABRIC ON YOUR PURCHASE ORDER:





Calculate the yards of fabric needed using the chart below. If ordering more than 10 identical units, call for fabric requirements

Clearly label your fabric package with:

- Purchase order #
- Dealer name
- Fabric description
- Yardage quantity enclosed

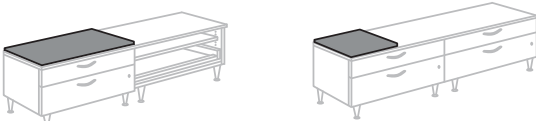
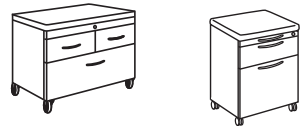

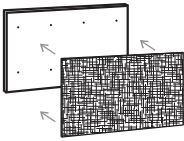



Please note: Lead-time for COM fabric orders starts after Great Openings receives the Fabric. Great Openings reserves the right to refuse to apply any COM fabric that we deem insufficient quality for production or user application. Our standard warranty does not apply to COM fabric-covered items.

Send the fabric to:
Great Openings (Fabric), 902 East Fourth St., Ludington, MI 49431

| Product | Required Yardage |
|--|---|
|  <p data-bbox="430 709 578 730">Cayenne Cushion</p> | <p data-bbox="875 579 1117 600">Required for 54" or 66" fabric</p> <ul data-bbox="875 600 1179 699" style="list-style-type: none"> 12" wide cushion (1/2 linear yard) 18" wide cushion (2/3 linear yard) 30" wide cushion (1 linear yard) 36" wide cushion (1-1/4 linear yards) 42" wide cushion (1-1/3 linear yards) |
|  <p data-bbox="261 894 418 915">Cushion FileCenter</p> <p data-bbox="451 894 597 915">Cushion Pedestal</p> <p data-bbox="678 894 722 915">Molly</p> | <p data-bbox="875 768 1117 789">Required for 54" or 66" fabric</p> <p data-bbox="875 810 1047 831">1 linear yard per unit</p> |
|  <p data-bbox="321 1066 391 1087">Chester</p> <p data-bbox="493 1066 553 1087">Lester</p> <p data-bbox="639 1066 683 1087">Slim</p> | <p data-bbox="875 951 1117 972">Required for 54" or 66" fabric</p> <ul data-bbox="875 993 1146 1052" style="list-style-type: none"> Chester (3/4 linear yard per unit) Lester (1/2 linear yard per unit) Slim (2/3 linear yard per unit) |
|  <p data-bbox="370 1241 638 1262">Trace Box/File Lateral Cushions</p> | <p data-bbox="875 1125 1117 1146">Required for 54" or 66" fabric</p> <ul data-bbox="875 1167 1271 1188" style="list-style-type: none"> • 30", 36", and 42" wide laterals (3/4 linear yard) |
|  <p data-bbox="313 1461 695 1482">Wall-Mounted Tack Board - Horizontal Bracket</p> | <p data-bbox="875 1304 1117 1325">Required for 54" or 66" fabric</p> <ul data-bbox="875 1346 1369 1482" style="list-style-type: none"> • 24" wide tack board requires 36" fabric (1 linear yard) • 30" wide tack board requires 36" fabric (1 linear yard) • 36" wide tack board requires 42" fabric (1-1/2 linear yards) • 42" wide tack board requires 48" fabric (1-1/2 linear yards) • 48" wide tack board requires 54" fabric (1-1/2 linear yards) • 54" wide tack board requires 66" fabric (2 linear yards) • 60" wide tack board requires 66" fabric (2 linear yards) |
|  <p data-bbox="289 1696 391 1717">Desk Hutch</p> <p data-bbox="570 1696 743 1717">Transaction Counter</p> | <p data-bbox="875 1535 1117 1556">Required for 54" or 66" fabric</p> <ul data-bbox="875 1577 1369 1713" style="list-style-type: none"> • 36" wide tack board requires 42" fabric (1-1/2 linear yard) • 42" wide tack board requires 48" fabric (1-1/2 linear yards) • 48" wide tack board requires 54" fabric (1-1/2 linear yards) • 54" wide tack board requires 66" fabric (2 linear yards) • 60" wide tack board requires 66" fabric (2 linear yards) • 66" wide tack board requires 72" fabric (2 linear yards) • 72" wide tack board requires 77" fabric (2-1/2 linear yards) |
|  <p data-bbox="272 1875 418 1896">Rectangle Screen</p> <p data-bbox="553 1875 773 1896">Scalloped-Shaped Screen</p> | <p data-bbox="875 1766 1117 1787">Required for 54" or 66" fabric</p> <ul data-bbox="875 1808 1341 1969" style="list-style-type: none"> • 23" wide screen requires 29" fabric (1 linear yard) • 29" wide screen requires 35" fabric (1 linear yard) • 35" wide screen requires 41" fabric (1-1/2 linear yards) • 41" wide screen requires 47" fabric (1-1/2 linear yards) • 47" wide screen requires 53" fabric (1-1/2 linear yards) • 59" wide screen requires 65" fabric (2 linear yards) • 65" wide screen requires 71" fabric (2 linear yards) • 71" wide screen requires 77" fabric (2-1/2 linear yards) <p data-bbox="245 1913 756 1969">The scalloped-shaped screens require the same amount of fabric as the rectangular screens. The 20-3/4" and 12" screen height dimension will be taken from the width of the cloth.</p> |

LOCK PROGRAM

SEE PAGE 2 FOR COLORS, LAMINATES, FABRICS

| | UM (our standard lock) | LL | SL | ML | HW | K |
|--|---|--|--|--|--|---|
| |  |  |  |  |  |  |
| | Black Patent | Satin Nickel, Scalloped | Grey Scalloped | Grey Scalloped | Satin Nickel, Scalloped | Black Patent |
| Compatible with which other Manufacturers? | Herman Miller | None | Haworth SL (Not Available on TRACE Hutch) | Haworth ML (Not Available on TRACE Hutch) | Haworth HW | Knoll Series |
| Interchangeable with other manufacturers' locks? | Interchangeable key and core | N/A | Interchangeable key and core | Interchangeable key and core | N/A | You cannot interchange K Series cores between Great Openings and Knoll products, but our "K" keys will operate Knoll's "K" locks, and vice versa |
| Description | As standard, all GO products are shipped with a randomly-assigned UM lock, which is black, master-keyed, and core removable | The LL lock is master-keyed and core removable | There is no master-key available for SL locks | Great Openings does not offer the Haworth ML series lock, but Haworth's ML lock cores will operate in our SL Lock mechanism. Order the SL lock and then replace the cores and keys with ML in the field. It is the dealer's responsibility to source and provide the ML cores and keys. | Great Openings does not offer the Haworth HW series lock, but Haworth's HW lock cores will operate in our LL Lock mechanism. Order the LL lock and then replace the cores and keys with HW in the field. It is the dealer's responsibility to source and provide the HW cores and keys. | Our K Series cores and keys will operate the Knoll K Series locks. Order the UM Series lock and then replace the cores and keys with K Series in the field. We support a key range of K-001 through K-100; should you require numbers K-101 through K-250, please contact Customer Service. |
| How to order | No special instructions are needed No extra charge | You must clearly specify "LL Series Locks" on your purchase order No extra charge | You must clearly specify "Haworth SL Series Locks" on your purchase order No extra charge | You must clearly specify "Haworth SL Series Locks" on your purchase order No extra charge | You must clearly specify "LL Series Locks" on your purchase order No extra charge | When ordering the product, no need for special ordering instructions; GO products ship as standard with UM locks You must also order K Series cores and keys separately, either random or with specified key codes No extra charge |
| Key # range | 226 to 425 (408 & 412 not available) | 226 to 325 | 1 to 300 | N/A | N/A | 1 to 250 |
| When shipped.... | UM core and key are randomly assigned | LL core and key are randomly assigned | SL core and key are randomly assigned | SL core and key are randomly assigned | LL core and key are randomly assigned | Products are shipped with UM Series lock housing, cores and keys |
| Key alike service available? (cores and keys will ship separately) | Yes, no charge Specify the desired key sequence on your PO, or specify "random" | Yes, no charge Specify the desired key sequence on your PO, or specify "random" | Yes, no charge Specify the desired key sequence on your PO, or specify "random" | No | No | Yes, no charge Specify the desired key sequence on your PO, or specify "random" |
| At installation.... | No extra steps are needed | No extra steps are needed | No extra steps are needed | Remove and dispose of the SL cores and keys, then replace with ML cores and keys | Remove and dispose of the LL cores and keys, then replace with HW cores and keys | Remove and dispose of the UM Series cores and keys, then replace with K Series cores and keys |

Key-Alike Process and Charges:

- Your key-alike request can be ordered on the original purchase order or under separate cover.
- Key-alike requests for the UM, SL, LL and K Series locks are processed at no charge as long as the quantity of key/core sets match the quantity of cabinets.
- When including the UM, SL, and LL Series locks, products will be shipped with randomly assigned cores/keys. Your key-alike requests for all lock series will be shipped separately and labeled to allow for easy change-out in the field, after the product is installed.
- A core-removal key is provided at no charge with each key-alike request.
- Additional keys, cores, master keys, and core keys may be purchased separately. The cost is \$3 net per item, plus \$15 net for shipping costs.

SEE PAGE 2 FOR COLORS, LAMINATES, FABRICS

TRACE pedestals feature horizontal lines and full-width fronts consistent with all other TRACE products.



Basic Construction

- All Great Openings products meet or exceed applicable ANSI-BIFMA standards for durability and safety
- A lifetime warranty ensures long-lasting performance and after-sale support
- Welded steel frame construction and formed channels ensure strength in key areas
- Top and side channels are 18 – 21 gauge cold rolled steel
- Outer panels and drawer bin are 22 gauge steel, drawer fronts are 20 gauge steel
- Weight limit of 200 lbs for mobile pedestals and cushion mobile storage
- Black plastic casters are 37mm, 2 locking and 2 non-locking, installed in the field
- Translucent casters are 50mm, all four casters are non-locking, installed in the field
- Four leveling glides with 1-5/8" adjustment ensure proper drawer alignment and operation. Leveling glides are not interchangeable with casters
- All drawers include full-extension steel ball-bearing slides
- Slides include "anti-rebound" and "quick disconnect" features
- Drawer fronts include rubber bumpers for quiet operation
- Can accommodate letter, legal, and ledger filing

Options and Accessories

- 6" box drawer dividers, 12" file drawer dividers that allow for side-to-side filing, and pencil trays are sold separately
- Laminate fronts are available. See the Specification Guide for details.
- Fronts are mechanically fastened and removable to maximize design flexibility
- Polyethylene drawer front filler for increased sound deadening is available as an upgrade
- Individually locking security drawers are available as an upgrade
- File dividers allow for side-to-side filing and are sold separately

Lock System

- Pedestals come standard with randomly-assigned UM Series locks (#226-425)
- UM locks are black-faced, master-keyed, and core-removable
- Locks may be keyed-alike in the field
- Other key series are available, including Haworth SL, bright nickel LL, and Knoll K. See the Specification Guide for details.
- TRACE pedestals may be ordered to include individually locking security drawers. Please see Pedestal Accessories.

Counterweights

- Freestanding, mobile, and cushion pedestals include a counterweight factory-installed
- Counterweights are not necessary for work surface supporting or hanging pedestals

Inner Drawer Dimensions For Drawer Pedestals

- Inside clear drawer bin width: 12.125"
- Inside clear drawer bin depths: 18" dp ped: 15.2", 22" dp ped: 18.25", 28" dp ped: 24.25"
- Inside clear drawer bin height: file drawer: 9.5", box drawer: 4.5", pencil drawer: 1.75"
- Inside clear drawer bin height for the hidden pencil drawer in Chester, Lester, and Slim: 2.5"

Drawer Load Capacity

- 3" pencil drawer: 50 lbs
- 6" box drawer: 50 lbs
- 12" file drawer: 70 lbs

SEE PAGE 2 FOR COLORS, LAMINATES, FABRICS

TRACE Cushion Mobile Pedestal

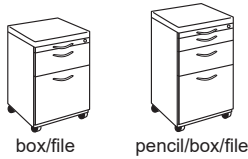

- 1-1/2" cushion is factory-installed with screws
- 1 linear yard required for COM fabric (20 units or fewer)
- Unless otherwise specified, the fabric grain on cushions will be applied "front-to-back"
- Counterweight included for stability
- When any loop pull is designated, a matching loop pull is included on the lock strip
- When any non-loop pull is designated, a Satin Nickel loop pull is included on the lock strip
- See the FAQ section to specify other than UM lock series, such as LL, SL, ML, HW, or K
- To specify an electronic lock instead of keyed lock, add an "E" after the "U" or "T" of the part number and add \$310 to the list price

In February, 2017 GO began a graded fabric program. The 15 "standard" fabrics shown on our finish card, and many more fabrics from Stinson and Maharam, are now priced as GRADE 1. See greatopenings.com for details.

| H | D | W | Caster Style | Drawer Options | Pkg Wt | Pkg Cube | Part # | Front Style | Part # | Metal Color | Fabric # | Part # | GR 1 Price | GR 2 Price | GR 3 Price | GR 4 Price | GR 5 Price | COM Price |
|--------|--------|--------|--------------|-----------------|--------|----------|--------|-------------|--------|-------------|----------|--------|------------|------------|------------|------------|------------|-----------|
| 23 | 18-7/8 | 15-1/4 | black | box/file | 60 lb | 5.9 ft | U ? | 1403 | ???? | ???? | N | | \$697 | \$755 | \$779 | \$802 | \$821 | \$692 |
| 23 | 21-7/8 | 15-1/4 | black | box/file | 70 lb | 6.6 ft | U ? | 1503 | ???? | ???? | N | | \$709 | \$767 | \$791 | \$814 | \$833 | \$704 |
| 23 | 18-7/8 | 15-1/4 | translucent | box/file | 60 lb | 5.9 ft | T ? | 1403 | ???? | ???? | N | | \$799 | \$857 | \$881 | \$904 | \$923 | \$794 |
| 23 | 21-7/8 | 15-1/4 | translucent | box/file | 70 lb | 6.6 ft | T ? | 1503 | ???? | ???? | N | | \$811 | \$869 | \$893 | \$916 | \$935 | \$806 |
| 25-7/8 | 18-7/8 | 15-1/4 | black | pencil/box/file | 70 lb | 6.1 ft | U ? | 1719 | ???? | ???? | N | | \$766 | \$824 | \$848 | \$871 | \$890 | \$761 |
| 25-7/8 | 21-7/8 | 15-1/4 | black | pencil/box/file | 75 lb | 6.8 ft | U ? | 1819 | ???? | ???? | N | | \$780 | \$838 | \$862 | \$885 | \$904 | \$775 |
| 25-7/8 | 18-7/8 | 15-1/4 | translucent | pencil/box/file | 70 lb | 6.1 ft | T ? | 1719 | ???? | ???? | N | | \$880 | \$938 | \$962 | \$985 | \$1,004 | \$875 |
| 25-7/8 | 21-7/8 | 15-1/4 | translucent | pencil/box/file | 75 lb | 6.8 ft | T ? | 1819 | ???? | ???? | N | | \$891 | \$949 | \$973 | \$996 | \$1,015 | \$886 |

| Available Fronts | A | B | D | F | H | I | N | P | Q | S | Y |
|----------------------|---|---|---|---|---|---|---|---|---|---|---|
| box and file drawers | A | B | D | F | H | I | N | P | Q | S | Y |
| pencil drawers | A | X | X | X | X | X | N | X | Q | S | Y |

For COM fabric ordering instructions, see the Specification Guide in the front of this book.

TRACE Mobile Pedestal

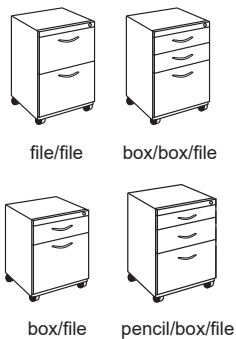

| H | D | W | Caster Style | Drawer Options | Pkg Wt | Pkg Cube | Part # | Front Style | Part # | Metal Color | Price |
|--------|--------|--------|--------------|-----------------|--------|----------|--------|-------------|--------|-------------|-------|
| 26-7/8 | 18-7/8 | 15-1/4 | black | file/file | 60 lb | 7.0 ft | EL ? | 2009 | ???? | | \$546 |
| | | | black | box/box/file | 64 lb | 7.0 ft | EL ? | 2011 | ???? | | \$603 |
| 26-7/8 | 21-7/8 | 15-1/4 | black | file/file | 68 lb | 8.0 ft | EL ? | 2109 | ???? | | \$553 |
| | | | black | box/box/file | 73 lb | 8.0 ft | EL ? | 2111 | ???? | | \$608 |
| 26-7/8 | 27-7/8 | 15-1/4 | black | file/file | 79 lb | 10.0 ft | EL ? | 2209 | ???? | | \$617 |
| | | | black | box/box/file | 85 lb | 10.0 ft | EL ? | 2211 | ???? | | \$650 |
| 21-1/8 | 18-7/8 | 15-1/4 | black | box/file | 54 lb | 5.6 ft | EL ? | 1403 | ???? | | \$500 |
| 21-1/8 | 21-7/8 | 15-1/4 | black | box/file | 63 lb | 6.3 ft | EL ? | 1503 | ???? | | \$512 |
| 21-1/8 | 27-7/8 | 15-1/4 | black | box/file | 73 lb | 7.8 ft | EL ? | 1603 | ???? | | \$556 |
| 24 | 18-7/8 | 15-1/4 | black | pencil/box/file | 73 lb | 7.8 ft | EL ? | 1719 | ???? | | \$597 |
| 24 | 21-7/8 | 15-1/4 | black | pencil/box/file | 73 lb | 7.8 ft | EL ? | 1819 | ???? | | \$619 |
| 24 | 27-7/8 | 15-1/4 | black | pencil/box/file | 73 lb | 7.8 ft | EL ? | 1919 | ???? | | \$633 |

- Includes four black casters, 2 locking and 2 non-locking
- Counterweight included for stability
- Special 21-1/8" height stows under work surface
- Mobile pedestals are not to be used as a chair
- A cushion may not be added to this mobile pedestal
- To add a satin nickle loop pull on the lockstrip (as shown on the Cushion Mobile Pedestal above). Add an "N" as a suffix to the part number and \$48 to the list price

| Available Fronts | A | B | D | F | H | I | N | P | Q | S | Y |
|----------------------|---|---|---|---|---|---|---|---|---|---|---|
| box and file drawers | A | B | D | F | H | I | N | P | Q | S | Y |
| pencil drawers | A | X | X | X | X | X | N | X | Q | S | Y |

SEE PAGE 2 FOR COLORS, LAMINATES, FABRICS

Chester



- Cushion is 1" foam, attached to metal top with dual-lock strips
- Linear yardage required for COM fabric (20 units or fewer): Chester - 1 yard
- Unless otherwise specified, the fabric grain on cushions will be applied "front-to-back"; the "front" is the side with drawers
- Counterweight included for stability
- Includes felt liner on compartment shelf
- A concealed pencil drawer includes 2-1/2" clearance, accessible when bottom drawer is open
- Hinged top include gas cylinder pneumatic guide
- When any loop pull is designated, a matching loop pull is included on the lid
- When any non-loop pull is designated, a Satin Nickel loop pull is included on the lid
- Includes two UM series lockers, keyed alike
- Electronic lock is not available
- Metal side bin is sold separately, and fits on either Chester or Lester

In February, 2017 GO began a graded fabric program. The 15 "standard" fabrics shown on our finish card, and many more fabrics from Stinson and Maharam, are now priced as GRADE 1. See greatopenings.com for details.

| H | D | W | Caster Style | Hinge Location | Pkg Wt | Pkg Cube | Part # | Front Style | Part # | Metal Color | Fabric | GR 1 Price | GR 2 Price | GR 3 Price | GR 4 Price | GR 5 Price | COM Price |
|-------|--------|--------|--------------|----------------|--------|----------|--------|-------------|--------|-------------|--------|------------|------------|------------|------------|------------|-----------|
| 23 | 23-1/2 | 15-1/4 | black | left | 78 lb | 8.9 ft | EGL | ? | 6565 | ???? | ???? | \$1,100 | \$1,188 | \$1,223 | \$1,258 | \$1,286 | \$1,095 |
| 23 | 23-1/2 | 15-1/4 | black | right | 78 lb | 8.9 ft | EGR | ? | 6565 | ???? | ???? | \$1,100 | \$1,188 | \$1,223 | \$1,258 | \$1,286 | \$1,095 |
| 23 | 23-1/2 | 15-1/4 | translucent | left | 78 lb | 8.9 ft | TGL | ? | 6565 | ???? | ???? | \$1,210 | \$1,298 | \$1,333 | \$1,368 | \$1,368 | \$1,205 |
| 23 | 23-1/2 | 15-1/4 | translucent | right | 78 lb | 8.9 ft | TGR | ? | 6565 | ???? | ???? | \$1,210 | \$1,298 | \$1,333 | \$1,368 | \$1,368 | \$1,205 |
| 5-3/4 | 2-1/2 | 15 | side bin | n/a | 5 lb | 1.5 ft | mfp | n/a | 0065 | ???? | n/a | | | | | | \$90 |

Available Fronts X B D F H K L M P Q S Y

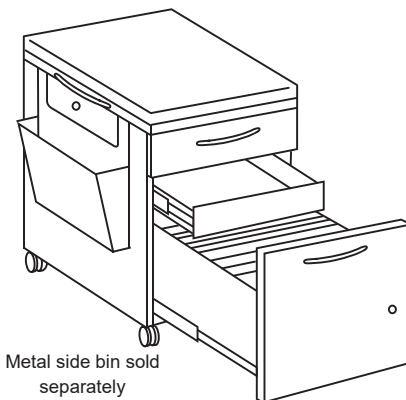
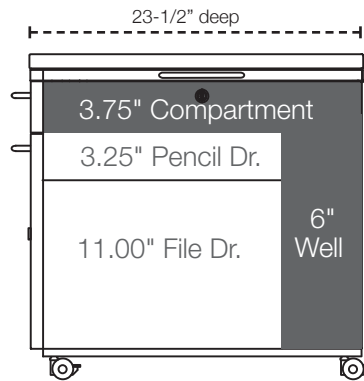
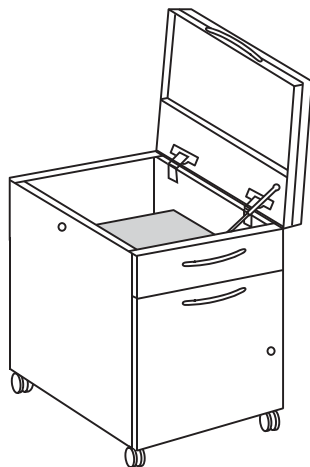
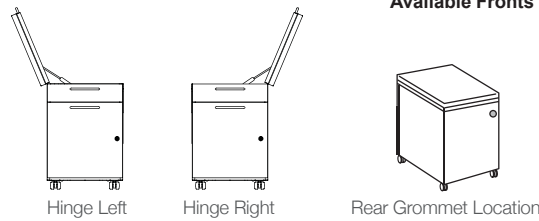

Metal side bin sold separately

Chester is 23-1/2" deep and includes a top access backpack storage well

SEE PAGE 2 FOR COLORS, LAMINATES, FABRICS

Lester



- Cushion is 1" foam, attached to metal top with dual-lock strips
- Linear yardage required for COM fabric (20 units or fewer): Lester - 3/4 yard
- Unless otherwise specified, the fabric grain on cushions will be applied "front-to-back"; the "front" is the side with drawers
- Counterweight included for stability
- Includes felt liner on compartment shelf
- A concealed pencil drawer includes 2-1/2" clearance, accessible when bottom drawer is open
- Hinged top include gas cylinder pneumatic guide
- When any loop pull is designated, a matching loop pull is included on the lid
- When any non-loop pull is designated, a Satin Nickel loop pull is included on the lid
- Includes two UM series lockers, keyed alike
- Electronic lock is not available
- Metal side bin is sold separately, and fits on either Chester or Lester

In February, 2017 GO began a graded fabric program. The 15 "standard" fabrics shown on our finish card, and many more fabrics from Stinson and Maharam, are now priced as GRADE 1. See greatopenings.com for details.

| H | D | W | Caster Style | Hinge Location | Pkg Wt | Pkg Cube | Part # | Front Style | Part # | Metal Color | Fabric | GR 1 Price | GR 2 Price | GR 3 Price | GR 4 Price | GR 5 Price | COM Price |
|-------|--------|--------|--------------|----------------|--------|----------|--------|-------------|--------|-------------|--------|------------|------------|------------|------------|------------|-----------|
| 23 | 17-7/8 | 15-1/4 | black | left | 68 lb | 5.9 ft | EGL | ? | 7566 | ???? | ???? | \$1,050 | \$1,108 | \$1,132 | \$1,155 | \$1,174 | \$1,045 |
| 23 | 17-7/8 | 15-1/4 | black | right | 68 lb | 5.9 ft | EGR | ? | 7566 | ???? | ???? | \$1,050 | \$1,108 | \$1,132 | \$1,155 | \$1,174 | \$1,045 |
| 23 | 17-7/8 | 15-1/4 | translucent | left | 68 lb | 5.9 ft | TGL | ? | 7566 | ???? | ???? | \$1,160 | \$1,218 | \$1,242 | \$1,265 | \$1,284 | \$1,155 |
| 23 | 17-7/8 | 15-1/4 | translucent | right | 68 lb | 5.9 ft | TGR | ? | 7566 | ???? | ???? | \$1,160 | \$1,218 | \$1,242 | \$1,265 | \$1,284 | \$1,155 |
| 5-3/4 | 2-1/2 | 15 | side bin | n/a | 5 lb | 1.5 ft | mfp | n/a | 0065 | ???? | n/a | | | | | | \$90 |

Available Fronts Q | S | Y

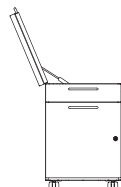

Hinge Left

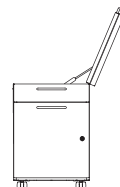

Hinge Right

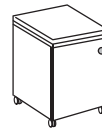

Rear Grommet Location

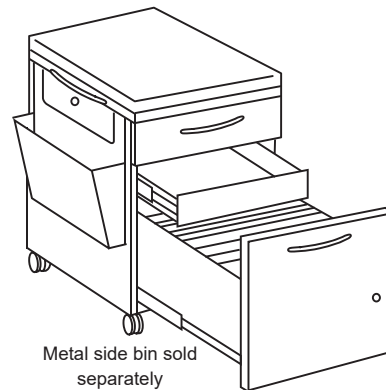
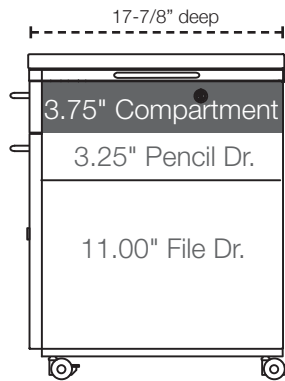
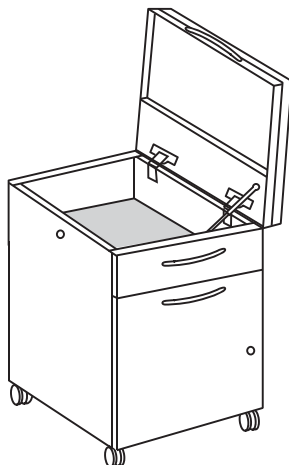

Metal side bin sold separately

Lester is a more compact 17-7/8" deep and does not include the backpack well. Other than that, the two brothers are identical

PEDESTALS/MOBILE STORAGE

SIN 711-3

SEE PAGE 2 FOR COLORS, LAMINATES, FABRICS

Slim

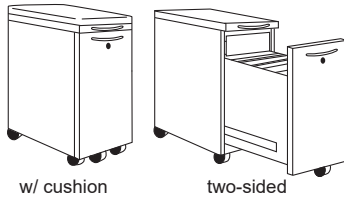

- The bottom drawer may be specified as single-sided (left or right) or two-sided
- A two-sided drawer includes file bars to accommodate letter or legal hanging files
- A concealed pencil drawer includes 2-1/2" clearance, accessible when bottom drawer is open
- A 5th caster, located under the bottom drawer, eliminates the need for counterweight
- Cushion is 1" foam, attached to metal top with dual-lock strips
- 3/4 linear yard required for COM fabric (20 units or fewer)
- Unless otherwise specified, the fabric grain on cushions will be applied "front-to-back"
- When any loop pull is designated, a matching loop pull is included on the lock strip
- When any non-loop pull is designated, a Satin Nickel loop pull is included on the lock strip
- Electronic lock is not available

In February, 2017 GO began a graded fabric program. The 15 "standard" fabrics shown on our finish card, and many more fabrics from Stinson and Maharam, are now priced as GRADE 1. See greatopenings.com for details.

| H | D | W | Description | Top Option | Drawer access from side | Pkg Wt | Pkg Cube | Part # | Front Style | Part # | Metal Color | Fabric | GR 1 Price | GR 2 Price | GR 3 Price | GR 4 Price | GR 5 Price | COM Price |
|----|--------|----|----------------------------|------------|-------------------------|--------|----------|--------|-------------|--------|-------------|--------|------------|------------|------------|------------|------------|-----------|
| 20 | 18-1/4 | 12 | one-sided drawer | Metal | Left | 41lb | 3.8 ft | SLU ? | 5638 | ???? | n/a | ???? | \$850 | n/a | n/a | n/a | n/a | n/a |
| 20 | 18-1/4 | 12 | one-sided drawer | Metal | Right | 41 lb | 3.8 ft | SRU ? | 5638 | ???? | n/a | ???? | \$850 | n/a | n/a | n/a | n/a | n/a |
| 20 | 18-1/4 | 12 | two-sided drw. & file bars | Metal | n/a | 41 lb | 3.8 ft | STU ? | 5640 | ???? | n/a | ???? | \$895 | n/a | n/a | n/a | n/a | n/a |
| 21 | 18-1/4 | 12 | one-sided drawer | Cushion | Left | 41 lb | 3.8 ft | SLU ? | 5638 | ???? | ???? | ???? | \$1,004 | \$1,062 | \$1,086 | \$1,109 | \$1,128 | \$999 |
| 21 | 18-1/4 | 12 | one-sided drawer | Cushion | Right | 41 lb | 3.8 ft | SRU ? | 5638 | ???? | ???? | ???? | \$1,004 | \$1,062 | \$1,086 | \$1,109 | \$1,288 | \$999 |
| 21 | 18-1/4 | 12 | two-sided drw. & file bars | Cushion | n/a | 41 lb | 3.8 ft | STU ? | 5640 | ???? | ???? | ???? | \$1,049 | \$1,107 | \$1,131 | \$1,154 | \$1,173 | \$1,044 |

Available Fronts | A | B | C | D | E | F | G | H | I | J | K | L | M | N | O | P | Q | S | Y

Molly

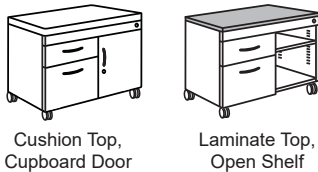

- 1-1/2" cushion is factory-installed with screws
- 1 linear yard required for COM fabric (20 units or fewer)
- Unless otherwise specified, the fabric grain on cushions will be applied "front-to-back"
- Box/File drawer may be specified on either left or right side
- Includes either open shelves or hinged door
- Hinges are always oriented on the outside of the cabinet
- Counterweight included for stability
- Electronic lock is not available

In February, 2017 GO began a graded fabric program. The 15 "standard" fabrics shown on our finish card, and many more fabrics from Stinson and Maharam, are now priced as GRADE 1. See greatopenings.com for details.

| H | D | W | Description | Drawer/Location | Caster Style | Pkg Wt | Pkg Cube | Part # | Front Style | Part # | Metal Color | Fabric | Laminate | GR 1 Price | GR 2 Price | GR 3 Price | GR 4 Price | GR 5 Price | COM Price |
|--------|--------|--------|-------------------|-----------------|--------------|--------|----------|--------|-------------|--------|-------------|--------|----------|------------|------------|------------|------------|------------|-----------|
| 22-3/8 | 18-1/4 | 30-1/2 | Cup. Dr./Lam. top | left | black | 120 lb | 12.2 ft | FL ? | L4G6 | ???? | N/A | ???? | ???? | \$1,010 | N/A | N/A | N/A | N/A | N/A |
| 22-3/8 | 18-1/4 | 30-1/2 | Cup. Dr./Lam. top | right | black | 120 lb | 12.2 ft | FR ? | L4T9 | ???? | N/A | ???? | ???? | \$1,010 | N/A | N/A | N/A | N/A | N/A |
| 22-3/8 | 18-1/4 | 30-1/2 | Open Sh./Lam. top | left | black | 116 lb | 12.2 ft | FL ? | L4U2 | ???? | N/A | ???? | ???? | \$918 | N/A | N/A | N/A | N/A | N/A |
| 22-3/8 | 18-1/4 | 30-1/2 | Open Sh./Lam. top | right | black | 116 lb | 12.2 ft | FR ? | L4U1 | ???? | N/A | ???? | ???? | \$918 | N/A | N/A | N/A | N/A | N/A |
| 23-1/4 | 18-1/4 | 30-1/2 | Cup. Dr./Cushion | left | black | 123 lb | 12.4 ft | FL ? | L4G6C | ???? | ???? | N/A | ???? | \$921 | \$1,038 | \$1,084 | \$1,131 | \$1,169 | \$916 |
| 23-1/4 | 18-1/4 | 30-1/2 | Cup. Dr./Cushion | right | black | 123 lb | 12.4 ft | FR ? | L4T9C | ???? | ???? | N/A | ???? | \$921 | \$1,038 | \$1,084 | \$1,131 | \$1,169 | \$916 |
| 23-1/4 | 18-1/4 | 30-1/2 | Open Sh./Cushion | left | black | 119 lb | 12.4 ft | FL ? | L4U2C | ???? | ???? | N/A | ???? | \$829 | \$946 | \$992 | \$1,039 | \$1,077 | \$824 |
| 23-1/4 | 18-1/4 | 30-1/2 | Open Sh./Cushion | right | black | 119 lb | 12.4 ft | FR ? | L4U1C | ???? | ???? | N/A | ???? | \$829 | \$946 | \$992 | \$1,039 | \$1,077 | \$824 |

Available Fronts | A | B | C | D | E | F | G | H | I | J | K | L | M | N | O | P | Q | S | Y

SEE PAGE 2 FOR COLORS, LAMINATES, FABRICS

In February, 2017 GO began a graded fabric program. The 15 "standard" fabrics shown on our finish card, and many more fabrics from Stinson and Maharam, are now priced as GRADE 1. See greatopenings.com for details.

**TRACE Cushion
Mobile FileCenter**



- 1-1/2" cushion is factory-installed with screws
- 1 linear yard required for COM fabric (20 units or fewer)
- Unless otherwise specified, the fabric grain on cushions will be applied "front-to-back"
- Counterweight included for stability
- Electronic lock is not available

| H | D | W | Caster Style | Pkg Wt | Pkg Cube | Part # | Front Style Part # | Metal Color | Fabric | GR 1 Price | GR 2 Price | GR 3 Price | GR 4 Price | GR 5 Price | COM Price |
|--------|--------|--------|--------------|--------|----------|--------|--------------------|-------------|--------|------------|------------|------------|------------|------------|-----------|
| 24-1/8 | 18-3/8 | 30-1/2 | black | 120 lb | 12.2 ft | FL ? | 0108 | ???? | ???? | \$1,588 | \$1,705 | \$1,751 | \$1,798 | \$1,836 | \$1,583 |
| 23-1/8 | 18-3/8 | 30-1/2 | trans. | 120 lb | 12.2 ft | FL ? | 0111 | ???? | ???? | \$1,956 | \$2,073 | \$2,119 | \$2,166 | \$2,204 | \$1,951 |

Available Fronts | A | ~~B~~ | ~~B~~ | F | H | ~~X~~ | ~~X~~ | P | Q | S | Y

For COM fabric ordering instructions, see the Specification Guide in the front of this book.

SEE PAGE 2 FOR COLORS, LAMINATES, FABRICS

TRACE Work Surface Supporting Pedestal



file/file box/box/file pencil/box/file

- Top channels attach to work surface
- Special 27" and 24-3/4" height accommodates low profile work surface
- Leveling glides allow for 1-5/8" adjustment
- Height listed includes leveling glides fully recessed
- WSS may not be used in a freestanding application

| H | D | W | Drawer Options | Pkg Wt | Pkg Cube | Part # | Front Style | Part # | Metal Color | Price |
|--------|--------|--------|-----------------|--------|----------|--------|-------------|--------|-------------|-------|
| 27-3/4 | 17-7/8 | 15-1/4 | file/file | 51 lb | 7.2 ft | EL | ? | 2909 | ???? | \$496 |
| | | | box/box/file | 53 lb | 7.2 ft | EL | ? | 2911 | ???? | \$538 |
| 27-3/4 | 21-7/8 | 15-1/4 | file/file | 56 lb | 8.6 ft | EL | ? | 3009 | ???? | \$501 |
| | | | box/box/file | 59 lb | 8.6 ft | EL | ? | 3011 | ???? | \$548 |
| 27-3/4 | 27-7/8 | 15-1/4 | file/file | 67 lb | 10.6 ft | EL | ? | 3109 | ???? | \$570 |
| | | | box/box/file | 70 lb | 10.6 ft | EL | ? | 3111 | ???? | \$597 |
| 27 | 21-7/8 | 15-1/4 | file/file | 55 lb | 8.4 ft | EL | ? | 3309 | ???? | \$523 |
| | | | box/box/file | 58 lb | 8.4 ft | EL | ? | 3311 | ???? | \$577 |
| 24-3/4 | 21-7/8 | 15-1/4 | pencil/box/file | 56 lb | 8.2 ft | EL | ? | 2719 | ???? | \$549 |
| 24-3/4 | 27-7/8 | 15-1/4 | pencil/box/file | 67 lb | 10.2 ft | EL | ? | 2819 | ???? | \$597 |

| Available Fronts | | | | | | | | | | | |
|----------------------|---|--------------|--------------|--------------|--------------|--------------|---|--------------|---|---|---|
| box and file drawers | A | B | D | F | H | I | N | P | Q | S | Y |
| pencil drawers | A | B | D | F | H | I | N | P | Q | S | Y |

TRACE Work Surface Supporting Pedestal Locker



Hinge on left

- Top channels attach to work surface
- Cupboard door may hinge right or left
- One adjustable shelf
- Binder height storage on one shelf only
- Leveling glides allow for 1-5/8" adjustment
- Height listed includes leveling glides fully recessed

| H | D | W | Hinge Location | Pkg Wt | Pkg Cube | Part # | Front Style | Part # | Metal Color | Price |
|--------|--------|--------|----------------|--------|----------|--------|-------------|--------|-------------|-------|
| 27-3/4 | 21-7/8 | 15-1/4 | right | 52 lb | 8.6 ft | CPRU | ? | 2721 | ???? | \$574 |
| 27-3/4 | 21-7/8 | 15-1/4 | left | 52 lb | 8.6 ft | CPLU | ? | 2721 | ???? | \$574 |

| Available Fronts | | | | | | | | | | |
|------------------|--------------|--------------|---|--------------|--------------|---|--------------|---|---|---|
| A | B | D | F | H | I | N | P | Q | S | Y |

TRACE Hanging Pedestal



- Hangs from work surface
- Quick-mount attachment with fasteners

| H | D | W | Drawer Options | Pkg Wt | Pkg Cube | Part # | Front Style | Part # | Metal Color | Price |
|--------|--------|--------|----------------|--------|----------|--------|-------------|--------|-------------|-------|
| 19-3/8 | 17-7/8 | 15-1/4 | box/file | 40 lb | 5.3 ft | EL | ? | 0503 | ???? | \$395 |
| 19-3/8 | 21-7/8 | 15-1/4 | box/file | 43 lb | 5.3 ft | EL | ? | 0603 | ???? | \$406 |
| 25 | 21-7/8 | 15-1/4 | box/box/file | 52 lb | 8.6 ft | EL | ? | 1211 | ???? | \$590 |
| 25 | 21-7/8 | 15-1/4 | file/file | 52 lb | 8.6 ft | EL | ? | 1209 | ???? | \$540 |

| Available Fronts | | | | | | | | | | |
|------------------|---|---|---|---|---|---|---|---|---|---|
| A | B | D | F | H | I | N | P | Q | S | Y |

SEE PAGE 2 FOR COLORS, LAMINATES, FABRICS

TRACE Freestanding Pedestal

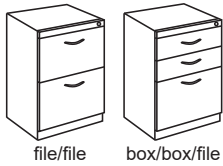

- Stationary pedestal includes counterweight
- Leveling glides allow for 1-5/8" adjustment

| H | D | W | Drawer Option | Pkg Wt | Pkg Cube | Part # | Front Style | Part # | Metal Color | Price |
|--------|--------|--------|---------------|--------|----------|--------|-------------|--------|-------------|-------|
| 27-3/4 | 18-7/8 | 15-1/4 | file/file | 68 lb | 7.6 ft | EL ? | 6109 | ???? | | \$507 |
| | | | box/box/file | 70 lb | 7.6 ft | EL ? | 6111 | ???? | | \$551 |
| 27-3/4 | 21-7/8 | 15-1/4 | file/file | 74 lb | 8.6 ft | EL ? | 5109 | ???? | | \$521 |
| | | | box/box/file | 76 lb | 8.6 ft | EL ? | 5111 | ???? | | \$568 |
| 27-3/4 | 27-7/8 | 15-1/4 | file/file | 83 lb | 10.6 ft | EL ? | 5309 | ???? | | \$586 |
| | | | box/box/file | 86 lb | 10.6 ft | EL ? | 5311 | ???? | | \$636 |

| | | | | | | | | | | | |
|------------------|---|---|---|---|---|---|---|---|---|---|---|
| Available Fronts | A | B | D | F | H | I | N | P | Q | S | Y |
|------------------|---|---|---|---|---|---|---|---|---|---|---|

TRACE V-Ped

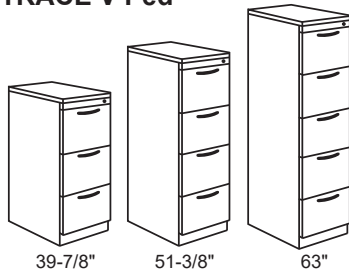

- Functions as a vertical file
- Does not include drawer compressor/divider (see file drawer dividers in pedestal accessories)
- Single lock captures all drawers
- Safety interlock is included, allowing only one drawer to open at a time
- Standard pedestal leveling glides allow for 1-5/8" adjustment
- Includes standard pedestal drawers, internal depth is 24-1/4"
- Compatible with all pedestal drawer accessories
- Finish height of 5 drawer v-ped is **not** consistent with TRACE products

| H | D | W | Drawer Option | Pkg Wt | Pkg Cube | Part # | Front Style | Part # | Metal Color | Price |
|--------|--------|--------|---------------|--------|----------|--------|-------------|--------|-------------|---------|
| 39-7/8 | 27-7/8 | 15-1/4 | 3 drawer | 85 lb | 12.9 ft | FL ? | 7143 | ???? | | \$1,198 |
| 51-3/8 | 27-7/8 | 15-1/4 | 4 drawer | 120 lb | 16.0 ft | FL ? | 7144 | ???? | | \$1,328 |
| 63 | 27-7/8 | 15-1/4 | 5 drawer | 145 lb | 20.3 ft | FL ? | 7245 | ???? | | \$1,462 |

| | | | | | | | | | | | |
|------------------|---|---|--------------|---|---|--------------|--------------|---|---|---|---|
| Available Fronts | A | B | D | F | H | I | N | P | Q | S | Y |
|------------------|---|---|--------------|---|---|--------------|--------------|---|---|---|---|

SEE PAGE 2 FOR COLORS, LAMINATES, FABRICS

Personal Drawer - Metal

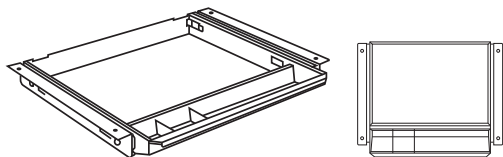

- Sleek, metal design allows the drawer to hide discretely beneath the desk
- Full extension steel ball-bearing slides
- Four integral storage compartments
- Mounts to underside of work surface using "L" brackets affixed to drawer slides
- Drawer and mounting brackets are 22 gauge steel
- Charcoal black powder coat finish
- Available with or without a lock
- Lock may also be ordered separately for later field installation

| Description | H | D | W | Pkg Wt | Pkg Cube | Part # | Price |
|------------------|-------|--------|--------|--------|----------|---------------|-------|
| Drawer with lock | 2-1/8 | 17-1/4 | 21-3/4 | 13 lb | 1 ft | NFC7657889-UM | \$293 |
| Drawer only | 2-1/8 | 17-1/4 | 21-1/2 | 13 lb | 1 ft | NFC7657889 | \$204 |
| Lock only | 2-1/8 | 1-1/2 | 1-1/2 | 1 lb | .5 ft | NFCX00020 | \$89 |

Pedestal Accessory Package Installed Prior to Shipment

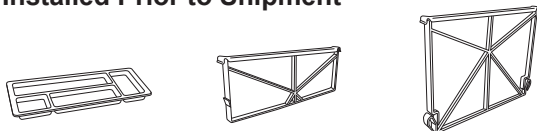

- Black plastic pencil tray includes 4 compartments and sits on top of drawer bin sides
- Black plastic drawer dividers snap in place. The 12" drawer divider may also be used as a file conversion bar for side-to-side filing, and as a file compressor
- Accessory package prices will be added to the standard pedestal prices

| Description | Options | Product # | Price |
|---|--------------|--|-------|
| file/file pedestals will include two 12" drawer dividers | file/file | add "A" as a suffix to the product number. | \$25 |
| box/box/file will include two 6" drawer dividers, one 12" drawer divider, and one pencil tray | box/box/file | add "A" as a suffix to the product number. | \$43 |
| box/file will include one 6" divider, one 12" divider and one pencil tray | box/file | add "A" as a suffix to the product number. | \$35 |

Pedestal Accessories – Sold Separately

- Individual pedestal accessories, described above, are packaged and sold separately

| Description | Options | Product # | Price |
|---------------------|----------------------------|---------------|-------|
| pencil Tray | single pencil tray | VMEX 000 29-1 | \$13 |
| box drawer divider | single box drawer divider | ECOX 1070-1 | \$10 |
| file drawer divider | single file drawer divider | ECOX 1071-1 | \$13 |

Security Pedestal Upgrade

- Pedestals that include box or file drawers may be converted to a security unit by adding a lock to each drawer and a security shelf between each drawer
- This (non-UM) double-bit security lock is conical in shape and chrome plated. Please call our Customer Service for lead-time information
- Security pedestal upgrade prices will be added to the standard pedestal price



| Description | Options | Product # | Price |
|---------------------------|--------------|---|-------|
| security pedestal upgrade | file/file | Add "EY" as a suffix to the product number. | \$198 |
| | box/box/file | Add "EY" as a suffix to the product number. | \$248 |

Available Fronts | A | ~~B~~ | D | F | ~~H~~ | ~~I~~ | N | ~~P~~ | Q | S | Y

Drawer Front Filler - Pedestals

- Pedestals with box or file drawers may be upgraded to include a closed cell polyethylene filler piece that adheres to the inside of the drawer front for improved sound dampening. (3" pencil drawers are enclosed as standard with a formed metal piece.)

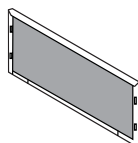

Inside View

- Drawer Front Filler upgrades, priced per drawer, will be added to the product list price.

| Description | Options | Product # | Price/Drw |
|---------------------|------------------|--|-----------|
| drawer front filler | price per drawer | Add "U" as a suffix to the product number. | \$13 |

Available Fronts | A | B | D | F | H | I | N | P | Q | S | Y

Basic Construction:

- Trace lateral files feature horizontal lines and full-width fronts consistent with all other TRACE products.
- All Great Openings products meet or exceed applicable ANSI-BIFMA standards for durability and safety
- A lifetime warranty ensures long-lasting performance and after-sale support
- Steel frame construction is welded and channels are formed in key areas for strength
- Reinforced vertical and horizontal channels ensure dimensional stability
- Inner frame is 20 gauge metal. Fronts, tops, outer panels are 20 and 22 gauge. Drawer bins and shelves are 18 and 20 gauge
- The horizontal lock strip on 4-high and 5-high laterals is located above the fourth drawer. In 6-high laterals, the lock strip is located above the fifth drawer

Features:

- The top opening of 5-high and 6-high laterals features an over-the-top flipper door with 13-1/4" inside clear height for binder storage
- All drawers and roll-out shelves include full extension steel ball-bearing slides with anti-rebound features to ensure smooth operation
- Drawer includes full-height side panels
- Two file bars are included in each drawer, for side-to-side filing
- Four leveling glides with 1-1/4" adjustment are included to ensure proper drawer alignment and operation
- All Great Openings' lateral drawer bins will accommodate A4, Letter, and Legal size filing

For Your Safety:

- The safety interlock mechanism is integrated into the slides, allowing only one drawer to open at a time
- All laterals with drawers and roll-out shelves used as freestanding units must have counter-weight if not ganged together or otherwise anchored
- Counterweights may be factory installed or purchased separately to be field installed

Options and Accessories:

- Drawer fronts and lateral tops are mechanically fastened and removable to maximize design flexibility
- Laminate fronts are available on all TRACE laterals. Please see the Specification Guide in the front of this book
- Drawer front fillers are available for improved sound dampening
- File conversion bars for front-to-back filing are sold separately
- Additional accessories include magnetic drawer/shelf dividers, magnetic labels, security bar lock, and drawer front fillers

Lock System:

- Lateral files come standard with randomly assigned UM Series locks (#226-425). Black faced, master-keyed, and core removable
- Locks may be keyed-alike in the field
- Other key series are available, including Haworth SL, bright nickel LL, and Knoll K. Please see the Specification Guide in the front of this book for details
- The locking system captures drawer fronts on both sides for added security

Trace Lateral Inner Drawer Dimensions:

- Inside drawer bin widths: 30" bin: 26.7", 36" bin: 32.7", 42" bin: 38.7"
- Inside height for flipper door compartment (both fixed and roll-out shelves): 13.25"
- Inside heights for 12" lateral drawers: drawer positioned immediately below a lock strip: 10.43", all other drawers: 10.75"
- Inside drawer bin heights for 6" lateral drawers: drawer positioned immediately below a lock strip: 4.7", all other drawers: 5.1"

Recessed Front Lateral Inner Drawer Dimensions:

- Inside drawer bin widths: 30" bin: 26.7", 36" bin: 32.7", 42" bin: 38.7"
- Inside depth for fixed shelves: 16.00"
- Inside height for 12" receding door compartment: 10.25"
- Inside height for 15" receding door compartment: 13.0"
- Inside heights for recessed front lateral drawers: 11.25"

Load Capacity:

- Drawer and roll-out shelf load capacity: 30" wide bin: 125 lbs, 36" wide bin: 125 lbs, 42" wide bin: 125 lbs
- Fixed and adjustable shelf weight capacity: 30" shelf: 95 lbs, 36" shelf: 116 lbs, 42" shelf: 136 lbs,
- Load capacity of top of all lateral files: 30" wide: 140 lbs, 36" wide: 168 lbs, 42" wide: 192 lbs



SEE PAGE 2 FOR COLORS, LAMINATES, FABRICS

TRACE Lateral File

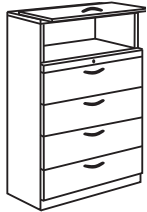

- Full-width, square edge drawer fronts
- 5-high and 6-high include top flipper door that stows over-the-top, revealing either a roll-out or fixed shelf
- Flipper compartment features 13-1/2" inside clear height for binder storage
- Counterweight is required if not ganged together or otherwise anchored
- Laminate tops are sold separately for individual laterals and laterals paired side-by-side or back-to-back (see lateral accessory section). Please note that a laminate top may not be placed on top of a Trace lateral that includes a flipper door on the top opening
- Four leveling glides with 1-1/4" adjustment are included to ensure proper drawer alignment and operation
- Inside clear drawer bin heights for Trace laterals: top flipper door compartment: 13.25", drawer positioned immediately below a lock strip: 10.43", all other drawers: 10.75"

| H | D | W | Drawer Options | Pkg Wt | Pkg Cube | Part # | Front # | Part # | Metal Color | Price |
|--------|--------|----|--------------------------|--------|----------|--------|---------|--------|-------------|---------|
| 28-3/8 | 18-1/4 | 30 | 2 drawer | 98 lb | 11.8 ft | RG | ? | C301 | ???? | \$867 |
| 28-3/8 | 18-1/4 | 36 | 2 drawer | 114 lb | 14.0 ft | RG | ? | C401 | ???? | \$927 |
| 28-3/8 | 18-1/4 | 42 | 2 drawer | 130 lb | 16.2 ft | RG | ? | C501 | ???? | \$1,018 |
| 39-7/8 | 18-1/4 | 30 | 3 drawer | 134 lb | 16.5 ft | RG | ? | C602 | ???? | \$1,173 |
| 39-7/8 | 18-1/4 | 36 | 3 drawer | 156 lb | 19.6 ft | RG | ? | C702 | ???? | \$1,248 |
| 39-7/8 | 18-1/4 | 42 | 3 drawer | 180 lb | 22.7 ft | RG | ? | C802 | ???? | \$1,376 |
| 51-3/8 | 18-1/4 | 30 | 4 drawer | 171 lb | 22.0 ft | RG | ? | C903 | ???? | \$1,446 |
| 51-3/8 | 18-1/4 | 36 | 4 drawer | 198 lb | 26.0 ft | RG | ? | D103 | ???? | \$1,537 |
| 51-3/8 | 18-1/4 | 42 | 4 drawer | 225 lb | 30.0 ft | RG | ? | D203 | ???? | \$1,692 |
| 65-7/8 | 18-1/4 | 30 | 5 drawer roll-out shelf | 207 lb | 28.0 ft | RG | ? | D304 | ???? | \$1,811 |
| 65-7/8 | 18-1/4 | 36 | 5 drawer roll-out shelf | 241 lb | 33.0 ft | RG | ? | D404 | ???? | \$1,923 |
| 65-7/8 | 18-1/4 | 42 | 5 drawer roll-out shelf | 275 lb | 38.0 ft | RG | ? | D504 | ???? | \$2,116 |
| 65-7/8 | 18-1/4 | 30 | 5 drawer fixed top shelf | 205 lb | 28.0 ft | RG | ? | D311 | ???? | \$1,746 |
| 65-7/8 | 18-1/4 | 36 | 5 drawer fixed top shelf | 240 lb | 33.0 ft | RG | ? | D411 | ???? | \$1,858 |
| 65-7/8 | 18-1/4 | 42 | 5 drawer fixed top shelf | 273 lb | 38.0 ft | RG | ? | D511 | ???? | \$2,052 |
| 77-3/8 | 18-1/4 | 30 | 6 drawer roll-out shelf | 243 lb | 32.6 ft | RG | ? | E778 | ???? | \$2,057 |
| 77-3/8 | 18-1/4 | 36 | 6 drawer roll-out shelf | 283 lb | 38.5 ft | RG | ? | E878 | ???? | \$2,298 |
| 77-3/8 | 18-1/4 | 42 | 6 drawer roll-out shelf | 325 lb | 44.5 ft | RG | ? | E978 | ???? | \$2,491 |

Available Fronts | A | B | F | H | P | Q | S | Y

Drawer load capacities:

- 30" drawer: 125 lbs
- 36" drawer: 125 lbs
- 42" drawer: 125 lbs



28-3/8"



39-7/8"



51-3/8"

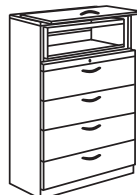

65-7/8"

roll-out top shelf



65-7/8"

fixed top shelf

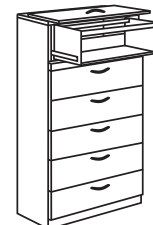

77-3/8"

roll-out top shelf

TRACE Lateral File Ganging Kit



- Rather than install a counterweight, an alternate method of ensuring lateral file stability is to gang two or more laterals together side-by-side or back-to-back
- Trace box/file laterals require a counterweight unless they are ganged back-to-back with another lateral file or otherwise tethered to a permanent structure. Without counterweights, ganging box/file laterals side-by-side will not ensure stability
- Ganging kit includes a drill template, screws, and instructions

| Description | Pkg Wt | Pkg Cube | Part # | Price |
|-----------------------------------|--------|----------|-------------|-------|
| Kit to gang two laterals together | 1 lb | .2 ft | LME 100010K | \$45 |

SEE PAGE 2 FOR COLORS, LAMINATES, FABRICS

In February, 2017 GO began a graded fabric program. The 15 "standard" fabrics shown on our finish card, and many more fabrics from Stinson and Maharam, are now priced as GRADE 1. See greatopenings.com for details.

TRACE Box/File Lateral

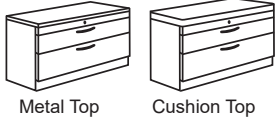

| H | D | W | Top | Drawer Options | Part # | Front # | Part # | Metal Color | Fabric | GR 1 Price | GR 2 Price | GR 3 Price | GR 4 Price | GR 5 Price | COM Price |
|--------|--------|----|---------|----------------|--------|---------|--------|-------------|--------|------------|------------|------------|------------|------------|-----------|
| 23-1/2 | 18-1/4 | 30 | Cushion | 6"/12" drawers | RG | ? | V3L7C | ???? | ???? | \$1,135 | \$1,223 | \$1,258 | \$1,293 | \$1,321 | \$1,130 |
| 23-1/2 | 18-1/4 | 36 | Cushion | 6"/12" drawers | RG | ? | V4L7C | ???? | ???? | \$1,204 | \$1,292 | \$1,327 | \$1,362 | \$1,390 | \$1,199 |
| 23-1/2 | 18-1/4 | 42 | Cushion | 6"/12" drawers | RG | ? | V5L7C | ???? | ???? | \$1,316 | \$1,404 | \$1,439 | \$1,474 | \$1,502 | \$1,311 |

- Includes one 6" drawer and one 12" drawer
- Cushion top is mechanically fastened to the lateral prior to shipment; cushions are 1-1/2" tall and include an enclosed wooden base
- Trace box/file laterals require a counterweight unless they are ganged back-to-back with another lateral file or otherwise tethered to a permanent structure. Without counterweights, ganging box/file laterals side-by-side will not ensure stability
- Inside clear drawer bin heights for 6" lateral drawers positioned immediately below a lock strip: 4.707, all 12" drawers have a 10.75" clearance from the bottom inside of that drawer bin to the bottom of the 6" drawer above it.
- Unless otherwise specified, the fabric grain on all cushions will be applied "front-to-back"

| H | D | W | Top | Drawer Options | Part # | Front # | Part # | Metal Color | Price |
|--------|--------|----|-------|------------------|--------|---------|--------|-------------|---------|
| 22-5/8 | 18-1/4 | 30 | Metal | 6" / 12" drawers | RG | ? | V3L7 | ???? | \$865 |
| 22-5/8 | 18-1/4 | 36 | Metal | 6" / 12" drawers | RG | ? | V4L7 | ???? | \$918 |
| 22-5/8 | 18-1/4 | 42 | Metal | 6" / 12" drawers | RG | ? | V5L7 | ???? | \$1,003 |

Available Fronts | A | B | B | F | H | H | H | H | H | H | H | H | H | H | H | Q | S | Y

TRACE Box/File Open Shelf Lateral

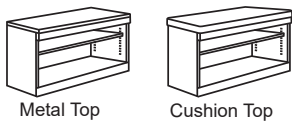

| H | D | W | Top | Shelf Options | Part # | Part # | Metal Color | Fabric | GR 1 Price | GR 2 Price | GR 3 Price | GR 4 Price | GR 5 Price | COM Price |
|--------|--------|----|---------|----------------|--------|--------|-------------|--------|------------|------------|------------|------------|------------|-----------|
| 22-1/2 | 18-1/4 | 30 | Cushion | 6"/12" shelves | ROS | V3M9 | ???? | ???? | \$958 | \$1,046 | \$1,081 | \$1,116 | \$1,144 | \$953 |
| 23-1/2 | 18-1/4 | 36 | Cushion | 6"/12" shelves | ROS | V4M9 | ???? | ???? | \$1,044 | \$1,132 | \$1,167 | \$1,202 | \$1,230 | \$1,039 |
| 23-1/2 | 18-1/4 | 42 | Cushion | 6"/12" shelves | ROS | V5M9 | ???? | ???? | \$1,139 | \$1,227 | \$1,262 | \$1,297 | \$1,325 | \$1,134 |

- Includes one adjustable shelf
- No counterweight is needed
- Cushion top is mechanically fastened to the lateral prior to shipment; cushions are 1-1/2" tall and include an enclosed wooden base
- See page 8 for fabric yardage requirements
- Allows for binder-height storage on one shelf
- Four leveling glides with adjustment are included to ensure proper alignment and operation
- Unless otherwise specified, the fabric grain on all cushions will be applied "front-to-back"

| H | D | W | Shelf Options | Top | Part # | Part # | Metal Color | Price |
|--------|--------|----|------------------|-------|--------|--------|-------------|-------|
| 22-5/8 | 18-1/4 | 30 | 6" / 12" shelves | Metal | ROS | V3M9 | ???? | \$688 |
| 22-5/8 | 18-1/4 | 36 | 6" / 12" shelves | Metal | ROS | V4M9 | ???? | \$758 |
| 22-5/8 | 18-1/4 | 42 | 6" / 12" shelves | Metal | ROS | V5M9 | ???? | \$826 |

In February, 2017 GO began a graded fabric program. The 15 "standard" fabrics shown on our finish card, and many more fabrics from Stinson and Maharam, are now priced as GRADE 1. See greatopenings.com for details.

SEE PAGE 2 FOR COLORS, LAMINATES, FABRICS

TRACE Counterweight – Factory Installed

- In order to satisfy ANSI-BIFMA standards for stability, counterweights are required for all lateral files that include roll-out drawers or shelves if they are not ganged together or otherwise anchored
- Fixed shelf lateral files do not require counterweights, nor do lateral files that are anchored to a wall or ganged together. See specific lateral file descriptions to determine counterweight requirements

| Description | Part # | Price |
|--------------------------|--|-------|
| 30" box/file drawer c-wt | Add a "W" suffix to the lateral file part number | \$147 |
| 36" box/file drawer c-wt | | \$162 |
| 42" box/file drawer c-wt | | \$188 |
| 2 drawer c-wt | | \$147 |
| 3 drawer c-wt | | \$147 |
| 4 drawer c-wt | | \$117 |
| 5 drawer c-wt | | \$117 |
| 6 drawer c-wt | | \$57 |

TRACE Counterweight – Sold Separately

- These counterweights are shipped separately to be installed at the work site
- In order to satisfy ANSI-BIFMA standards for stability, counterweights are required for all lateral files that include roll-out drawers or shelves if they are not ganged together or otherwise anchored
- Fixed shelf lateral files do not require counterweights, nor do lateral files that are anchored to a wall or ganged together. See specific lateral file descriptions to determine counterweight requirements

| Description | Pkg Wt | Pkg Cube | Part # | Price |
|--------------------------|---------|----------|----------|-------|
| 30" box/file drawer c-wt | 42 lb | .7 ft | TRA 2300 | \$241 |
| 36" box/file drawer c-wt | 52 lb | .8 ft | TRA 5500 | \$305 |
| 42" box/file drawer c-wt | 63 lb | .8 ft | TRA 6500 | \$355 |
| 2 drawer c-wt | 42 lb | .7 ft | TRA 2300 | \$241 |
| 3 drawer c-wt | 42 lb | .7 ft | TRA 2300 | \$241 |
| 4 drawer c-wt | 31.5 lb | .6 ft | TRA 4500 | \$194 |
| 5 drawer c-wt | 31.5 lb | .6 ft | TRA 4500 | \$194 |
| 6 drawer c-wt | 10.5 lb | .6 ft | TRA 6000 | \$96 |

TRACE Lateral Files with 6" Drawer



- Choose from several combinations of 6" and 12" drawers
- Inside drawer bin widths: 30" bin: 26.7", 36" bin: 32.7", 42" bin: 38.7"
- Inside heights for 12" lateral drawers: drawer positioned immediately below a lock strip: 10.43", all other drawers: 10.75"
- Inside drawer bin heights for 6" lateral drawers: drawer positioned immediately below a lock strip: 4.7", all other drawers: 5.1"
- 6" drawer dividers and felt drawer liners are sold separately. See lateral file accessories

Concerning Counterweight:

Laterals with all 6 inch drawers require no counterweight

Laterals with a combination of 6 inch drawers and 12 inch drawers do require counterweight if not ganged together or otherwise anchored. Select counterweight by the height of the cabinet, rather than number of drawers:

- 27-3/4" = 2-high
- 39-7/8" = 3-high
- 52" = 4-high

| H | D | W | Drawer Options | Pkg Wt | Pkg Cube | Part # | Front # | Part # | Color # | Price |
|--------|--------|----|-----------------------------|--------|----------|--------|---------|--------|---------|---------|
| 28-3/8 | 18-1/4 | 30 | (4) 6" drws | 113 lb | 11.8 ft | RG | ? | C307 | ???? | \$1,225 |
| 28-3/8 | 18-1/4 | 36 | (4) 6" drws | 132 lb | 14.0 ft | RG | ? | C407 | ???? | \$1,303 |
| 28-3/8 | 18-1/4 | 42 | (4) 6" drws | 151 lb | 16.2 ft | RG | ? | C507 | ???? | \$1,405 |
| 39-7/8 | 18-1/4 | 30 | (6) 6" drws | 159 lb | 16.5 ft | RG | ? | C606 | ???? | \$1,570 |
| 39-7/8 | 18-1/4 | 36 | (6) 6" drws | 186 lb | 19.6 ft | RG | ? | C706 | ???? | \$1,674 |
| 39-7/8 | 18-1/4 | 42 | (6) 6" drws | 213 lb | 22.7 ft | RG | ? | C806 | ???? | \$1,810 |
| 51-3/8 | 18-1/4 | 30 | (8) 6" drws | 206 lb | 21.3 ft | RG | ? | C905 | ???? | \$1,965 |
| 51-3/8 | 18-1/4 | 36 | (8) 6" drws | 240 lb | 25.2 ft | RG | ? | D105 | ???? | \$2,096 |
| 51-3/8 | 18-1/4 | 42 | (8) 6" drws | 274 lb | 29.1 ft | RG | ? | D205 | ???? | \$2,260 |
| 28-3/8 | 18-1/4 | 30 | (2) 6" drws (1) 12" drw | 103 lb | 11.8 ft | RG | ? | C338 | ???? | \$1,005 |
| 28-3/8 | 18-1/4 | 36 | (2) 6" drws (1) 12" drw | 120 lb | 14.0 ft | RG | ? | C438 | ???? | \$1,064 |
| 28-3/8 | 18-1/4 | 42 | (2) 6" drws (1) 12" drw | 137 lb | 16.2 ft | RG | ? | C538 | ???? | \$1,150 |
| 39-7/8 | 18-1/4 | 30 | (2) 6" drws (2) 12" drws | 139 lb | 16.5 ft | RG | ? | C641 | ???? | \$1,349 |
| 39-7/8 | 18-1/4 | 36 | (2) 6" drws (2) 12" drws | 162 lb | 19.6 ft | RG | ? | C741 | ???? | \$1,437 |
| 39-7/8 | 18-1/4 | 42 | (2) 6" drws (2) 12" drws | 185 lb | 22.7 ft | RG | ? | C841 | ???? | \$1,550 |
| 51-3/8 | 18-1/4 | 30 | (2) 6" drws (3) 12" drws | 176 lb | 21.3 ft | RG | ? | C940 | ???? | \$1,650 |
| 51-3/8 | 18-1/4 | 36 | (2) 6" drws (3) 12" drws | 204 lb | 25.2 ft | RG | ? | D140 | ???? | \$1,757 |
| 51-3/8 | 18-1/4 | 42 | (2) 6" drws (3) 12" drws | 232 lb | 29.1 ft | RG | ? | D240 | ???? | \$1,895 |

Available Fronts | A B C D E F G H I J K L M N O P Q S Y

SEE PAGE 2 FOR COLORS, LAMINATES, FABRICS

TRACE Individual Lateral File Laminate Top



- Factory installed or shipped separately
- A laminate top may not be placed on a Trace lateral that includes a flipper door in the top opening
- When factory installed, list price shown will be added to the accompanying lateral price
- Metal top is not included when using a laminate top
- Finish height of lateral file will be 5/8" taller than the height of a standard Trace lateral file with metal top
- Specify any standard GO laminate and edge. Special order laminates may require an up-charge; call for details
- Laminate tops used on individual lateral files are sized to be flush with the sides of the lateral, so that individual laterals installed side-by-side will have no gaps between

| Description | W | D | Part # | Laminate # | Price |
|------------------------|----|--------|--|------------|-------|
| factory installed | 30 | 18-1/4 | Add laminate color as a suffix to the lateral product number | ???? | \$344 |
| | 36 | 18-1/4 | Add this price to lateral price | ???? | \$385 |
| | 42 | 18-1/4 | | ???? | \$427 |
| top shipped separately | 30 | 18-1/4 | FC 1931 | ???? | \$413 |
| | 36 | 18-1/4 | FC 1937 | ???? | \$462 |
| | 42 | 18-1/4 | FC 1943 | ???? | \$512 |

Common Laminate Tops for TRACE Lateral Files

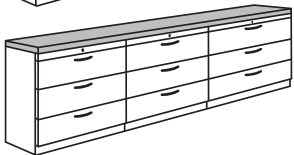

- Laminate tops ordered separately for field installation
- A laminate top may not be placed on a Trace lateral that includes a flipper door in the top opening
- Specify any standard GO laminate or special ordered laminate
- Note that these tops will fit ONLY TRACE lateral files
- Top sizes allow for 1/8" overhang on all sides

| | W | D | Pkg Wt | Pkg Cube | Part # | Price |
|-------------------------------------|---------|--------|--------|----------|----------|---------|
| Two Laterals Side-by-Side: | | | | | | |
| (2) 30" Lateral | 60-1/4 | 18-1/2 | 37 lb | .8 ft | TL 1860 | \$467 |
| (1) 30" & (1) 36" Lateral | 66-1/4 | 18-1/2 | 41 lb | .9 ft | TL 1866 | \$509 |
| (2) 36" Lateral | 72-1/4 | 18-1/2 | 45 lb | 1.0 ft | TL 1872 | \$550 |
| (2) 42" Lateral | 84-1/4 | 18-1/2 | 52 lb | 1.1 ft | TL 1884 | \$602 |
| Three Laterals Side-by-Side: | | | | | | |
| (3) 30" Lateral | 90-1/4 | 18-1/2 | 56 lb | 1.2 ft | TL 1890 | \$607 |
| (3) 36" Lateral | 108-1/4 | 18-1/2 | 67 lb | 1.4 ft | TL 18108 | \$785 |
| (3) 42" Lateral | 126-1/4 | 18-1/2 | 78 lb | 1.7 ft | TL 18126 | \$985 |
| Two Laterals Back-to-Back: | | | | | | |
| (2) 30" Lateral | 30-1/4 | 36-3/4 | 37 lb | .8 ft | TL 3730 | \$490 |
| (2) 36" Lateral | 36-1/4 | 36-3/4 | 45 lb | 1.0 ft | TL 3736 | \$593 |
| (2) 42" Lateral | 42-1/4 | 36-3/4 | 52 lb | 1.1 ft | TL 3742 | \$598 |
| Four Laterals in Quads: | | | | | | |
| (4) 30" Lateral | 60-1/4 | 36-3/4 | 74 lb | 1.6 ft | TL 3760 | \$788 |
| (4) 36" Lateral | 72-1/4 | 36-3/4 | 88 lb | 1.9 ft | TL 3772 | \$973 |
| (4) 42" Lateral | 84-1/4 | 36-3/4 | 103 lb | 2.2 ft | TL 3784 | \$1,025 |

SEE PAGE 2 FOR COLORS, LAMINATES, FABRICS

**TRACE Combo
Lateral File/Storage Cabinet**



2 drawer, 38"
cupboard, 65-7/8"



3 drawer, 27"
cupboard, 65-7/8"



3 drawer, 38"
cupboard, 77-3/8"



4 drawer, 27"
cupboard, 77-3/8"

- Includes two UM Series locks, keyed alike
- Units with 2-high cupboards allow binder storage on one shelf
- Units with 3-high cupboards allow binder storage on two shelves
- Counterweights are required in some models, and are included as standard

| H | D | W | # 12" Drawers | Cpbd Ht | Pkg Wt | Pkg Cube | Part # | Front | Part # | Metal Color | Price |
|--------|--------|----|---------------|---------|--------|----------|--------|-------|--------|-------------|---------|
| 51-3/8 | 18-1/4 | 30 | 2 drawer | 2-high | 166 lb | 22.0 ft | RG | ? | G7B9 | ???? | \$1,713 |
| 51-3/8 | 18-1/4 | 36 | 2 drawer | 2-high | 181 lb | 25.8 ft | RG | ? | G8B9 | ???? | \$2,037 |
| 51-3/8 | 18-1/4 | 42 | 2 drawer | 2-high | 206 lb | 28.6 ft | RG | ? | G9B9 | ???? | \$2,217 |
| 65-7/8 | 18-1/4 | 30 | 2 drawer | 3-high | 188 lb | 26.0 ft | RG | ? | H1B2 | ???? | \$2,047 |
| 65-7/8 | 18-1/4 | 36 | 2 drawer | 3-high | 203 lb | 30.8 ft | RG | ? | H2B2 | ???? | \$2,276 |
| 65-7/8 | 18-1/4 | 42 | 2 drawer | 3-high | 234 lb | 35.6 ft | RG | ? | H3B2 | ???? | \$2,509 |
| 65-7/8 | 18-1/4 | 30 | 3 drawer | 2-high | 183 lb | 26.0 ft | RG | ? | H4B3 | ???? | \$2,109 |
| 65-7/8 | 18-1/4 | 36 | 3 drawer | 2-high | 212 lb | 30.8 ft | RG | ? | H5B3 | ???? | \$2,342 |
| 65-7/8 | 18-1/4 | 42 | 3 drawer | 2-high | 231 lb | 35.6 ft | RG | ? | H6B3 | ???? | \$2,610 |
| 77-3/8 | 18-1/4 | 30 | 3 drawer | 3-high | 206 lb | 30.7 ft | RG | ? | H7B1 | ???? | \$2,441 |
| 77-3/8 | 18-1/4 | 36 | 3 drawer | 3-high | 234 lb | 36.4 ft | RG | ? | H8B1 | ???? | \$2,713 |
| 77-3/8 | 18-1/4 | 42 | 3 drawer | 3-high | 260 lb | 42.1 ft | RG | ? | H9B1 | ???? | \$3,022 |
| 77-3/8 | 18-1/4 | 30 | 4 drawer | 2-high | 210 lb | 30.7 ft | RG | ? | J1B4 | ???? | \$2,502 |
| 77-3/8 | 18-1/4 | 36 | 4 drawer | 2-high | 230 lb | 36.4 ft | RG | ? | J2B4 | ???? | \$2,783 |
| 77-3/8 | 18-1/4 | 42 | 4 drawer | 2-high | 254 lb | 42.1 ft | RG | ? | J3B4 | ???? | \$3,099 |

Available Fronts | A | B | F | H | P | Q | S | Y
 B, H, and P fronts will include "A" pull on cupboard doors

**TRACE Combo
Lateral File/Open Shelves**



2 drawer
38" shelves
65-7/8"



3 drawer
27" shelves
65-7/8"



3 drawer
38" shelves
77-3/8"



4 drawer
27" shelves
77-3/8"

- Include one UM Series lock
- Units with 2-high shelves allow binder storage on one shelf
- Units with 3-high shelves allow binder storage on two shelves
- Counterweights are required in some models, and are included as standard
- All drawer fronts and bins are standard height

| H | D | W | # 12" Drawers | Cpbd Ht | Pkg Wt | Pkg Cube | Part # | Front | Part # | Metal Color | Price |
|--------|--------|----|---------------|---------|--------|----------|--------|-------|--------|-------------|---------|
| 51-3/8 | 18-1/4 | 30 | 2 drawer | 2-high | 159 lb | 22.0 ft | RG | ? | F1A8 | ???? | \$1,604 |
| 51-3/8 | 18-1/4 | 36 | 2 drawer | 2-high | 188 lb | 25.8 ft | RG | ? | F2A8 | ???? | \$1,761 |
| 51-3/8 | 18-1/4 | 42 | 2 drawer | 2-high | 199 lb | 28.6 ft | RG | ? | F3A8 | ???? | \$1,941 |
| 65-7/8 | 18-1/4 | 30 | 2 drawer | 3-high | 174 lb | 26.0 ft | RG | ? | F490 | ???? | \$1,843 |
| 65-7/8 | 18-1/4 | 36 | 2 drawer | 3-high | 200 lb | 30.8 ft | RG | ? | F590 | ???? | \$2,070 |
| 65-7/8 | 18-1/4 | 42 | 2 drawer | 3-high | 216 lb | 35.6 ft | RG | ? | F690 | ???? | \$2,303 |
| 65-7/8 | 18-1/4 | 30 | 3 drawer | 2-high | 168 lb | 26.0 ft | RG | ? | F789 | ???? | \$1,938 |
| 65-7/8 | 18-1/4 | 36 | 3 drawer | 2-high | 194 lb | 30.8 ft | RG | ? | F889 | ???? | \$2,172 |
| 65-7/8 | 18-1/4 | 42 | 3 drawer | 2-high | 212 lb | 36.6 ft | RG | ? | F989 | ???? | \$2,439 |
| 77-3/8 | 18-1/4 | 30 | 3 drawer | 3-high | 183 lb | 30.7 ft | RG | ? | G197 | ???? | \$2,237 |
| 77-3/8 | 18-1/4 | 36 | 3 drawer | 3-high | 206 lb | 36.4 ft | RG | ? | G297 | ???? | \$2,509 |
| 77-3/8 | 18-1/4 | 42 | 3 drawer | 3-high | 229 lb | 42.1 ft | RG | ? | G397 | ???? | \$2,816 |
| 77-3/8 | 18-1/4 | 30 | 4 drawer | 2-high | 179 lb | 30.7 ft | RG | ? | G498 | ???? | \$2,332 |
| 77-3/8 | 18-1/4 | 36 | 4 drawer | 2-high | 202 lb | 36.4 ft | RG | ? | G598 | ???? | \$2,612 |
| 77-3/8 | 18-1/4 | 42 | 4 drawer | 2-high | 224 lb | 42.1 ft | RG | ? | G698 | ???? | \$2,927 |

Available Fronts | A | B | F | H | P | Q | S | Y

SEE PAGE 2 FOR COLORS, LAMINATES, FABRICS

TRACE Work Surface Supporting Lateral File



- Standard TRACE lateral file without top
- Standard depth: 18-1/4"
- Top channels designed to mount under work surface
- Safety interlock is included
- Counterweight is not required if installed beneath a desk work surface or otherwise anchored or ganged to another file.
- Not to be used as a freestanding cabinet, as no counter weight is included

| H | D | W | Drawer Options | Pkg Wt | Pkg Cube | Part # | Front # | Part # | Metal Color # | Part # | Price |
|--------|--------|----|----------------|--------|----------|--------|---------|--------|---------------|--------|---------|
| 27-3/4 | 18-1/4 | 30 | 2 drawer | 80 lb | 11.8 ft | RG | ? | C301 | ???? | NT | \$857 |
| 27-3/4 | 18-1/4 | 36 | 2 drawer | 102 lb | 14.0 ft | RG | ? | C401 | ???? | NT | \$916 |
| 27-3/4 | 18-1/4 | 42 | 2 drawer | 115 lb | 16.2 ft | RG | ? | C501 | ???? | NT | \$1,001 |

| | | | | | | | | | | | |
|------------------|---|---|--------------|---|---|--------------|--------------|---|---|---|---|
| Available Fronts | A | B | C | F | H | K | L | P | Q | S | Y |
|------------------|---|---|--------------|---|---|--------------|--------------|---|---|---|---|

TRACE Work Surface Supporting Multi drawer FileCenter

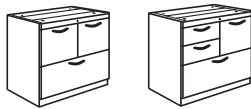

12-12-30 6-6-12-30

- Top channels mount under work surface
- Standard depth: 18-1/4"
- All drawers include full-extension steel ball bearing slides
- Counterweight is not required if installed beneath a desk work surface or otherwise anchored or ganged to another file.

| H | D | W | Cabinet Style | Pkg Wt | Pkg Cube | Part # | Front # | Part # | Metal Color # | Price |
|--------|--------|--------|---------------|--------|----------|--------|---------|--------|---------------|---------|
| 27-3/4 | 18-1/4 | 30-1/2 | 12"/12"/30" | 95 lb | 11.8 ft | WL | ? | 0102 | ???? | \$1,129 |
| 27-3/4 | 18-1/4 | 30-1/2 | 6"/6"/12"/30" | 105 lb | 11.8 ft | WL | ? | 0103 | ???? | \$1,181 |
| 27-3/4 | 18-1/4 | 30-1/2 | 12"/6"/6"/30" | 105 lb | 11.8 ft | WL | ? | 0104 | ???? | \$1,181 |

| | | | | | | | | | | | |
|------------------|---|--------------|--------------|---|---|--------------|--------------|---|---|---|---|
| Available Fronts | A | B | C | F | H | K | L | P | Q | S | Y |
|------------------|---|--------------|--------------|---|---|--------------|--------------|---|---|---|---|

TRACE Open Shelf Laterals

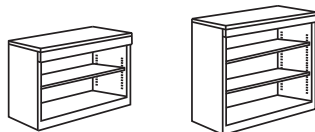

- Matches the height, depth, width, and horizontal lines of Trace Laterals and Double Door Storage Cabinets
- Includes 3" kick plate and metal top identical to Trace Laterals and Double Door Storage Cabinets
- Four leveling glides with 1 1/4" adjustment
- Shelves adjust in 1/2" increments
- 2-high allows for binder storage on 1 shelf
- 3-high allows for binder storage on 2 shelves
- Metal top may be replaced with laminate top
- Shelf load capacity all widths: 140 lbs
- Laminate is factory installed
- Metal top is not included when using a laminate top
- Finish height of open shelf lateral with laminate top will be 5/8" taller than the height of a standard open shelf lateral file with metal top
- Specify any standard GO laminate and edge
- Metal and outer side panels are flush with sides of bookcase top, so no gap between bookcases when installed side-by-side
- Laminate tops used on individual open shelf lateral files are sized to be flush with the sides of the lateral, so that individual open shelf laterals installed side-by-side will have no gaps between

| H | D | W | Top | Shelf Options | Pkg Wt | Pkg Cube | Part # | Metal Color | Lam/Edge # | Price |
|--------|--------|----|-------|----------------------|--------|----------|-----------|-------------|------------|---------|
| 28-3/8 | 18-1/4 | 30 | Metal | 2-high lateral | 65 lb | 10.0 ft | ROSX601 | ???? | | \$754 |
| 28-3/8 | 18-1/4 | 36 | Metal | 1 adjustable shelf | 77 lb | 11.3 ft | ROSX701 | ???? | | \$785 |
| 28-3/8 | 18-1/4 | 42 | Metal | | 88 lb | 13.0 ft | ROSX801 | ???? | | \$863 |
| 28-3/8 | 18-1/4 | 30 | Lam. | 2-high lateral | 65 lb | 10.0 ft | ROSX601LT | ???? | ???? | \$992 |
| 28-3/8 | 18-1/4 | 36 | Lam. | 1 adjustable shelf | 77 lb | 11.3 ft | ROSX701LT | ???? | ???? | \$1,048 |
| 28-3/8 | 18-1/4 | 42 | Lam. | | 88 lb | 13.0 ft | ROSX801LT | ???? | ???? | \$1,151 |
| 39-7/8 | 18-1/4 | 30 | Metal | 3-high lateral | 79 lb | 13.6 ft | ROSX902 | ???? | | \$835 |
| 39-7/8 | 18-1/4 | 36 | Metal | 2 adjustable shelves | 91 lb | 16.1 ft | ROSY102 | ???? | | \$869 |
| 39-7/8 | 18-1/4 | 42 | Metal | | 103 lb | 18.6 ft | ROSY202 | ???? | | \$957 |
| 39-7/8 | 18-1/4 | 30 | Lam. | 3-high lateral | 79 lb | 13.6 ft | ROSX902LT | ???? | ???? | \$1,053 |
| 39-7/8 | 18-1/4 | 36 | Lam. | 2 adjustable shelves | 91 lb | 16.1 ft | ROSY102LT | ???? | ???? | \$1,097 |
| 39-7/8 | 18-1/4 | 42 | Lam. | | 103 lb | 18.6 ft | ROSY202LT | ???? | ???? | \$1,219 |

SEE PAGE 2 FOR COLORS, LAMINATES, FABRICS

TRACE File Hutch

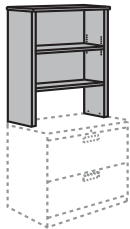

- Designed to set on laminate work surface, typically on top of a lateral file or double door storage cabinet
- May also be placed on top of recessed front lateral files
- Depth and height matches TRACE desk hutch
- Side panels attach to laminate top, fasteners included
- Back panel extends from bottom of fixed shelf to file hutch top
- One fixed shelf is 12" from bottom, one adjustable shelf
- Ships assembled

| H | D | W | Pkg Wt | Pkg Cube | Part # | Metal Color # | Price |
|----|--------|----|--------|----------|----------|---------------|-------|
| 37 | 12-3/4 | 30 | 51 lb | 10.6 ft | FLN 3012 | ???? | \$568 |
| 37 | 12-3/4 | 36 | 60 lb | 12.6 ft | FLN 3612 | ???? | \$590 |
| 37 | 12-3/4 | 42 | 72 lb | 14.6 ft | FLN 4212 | ???? | \$606 |

TRACE Freestanding Multidrawer FileCenter With Metal Top



12-12-30



6-6-12-30

- Structurally identical to work surface supporting multidrawer FileCenter
- Safety interlock and counterweight ensure stability, and are included

| H | D | W | Cabinet Style | Pkg Wt | Pkg Cube | Part # | Front # | Part # | Metal Color # | Price | |
|--------|--------|--------|---------------|--------|----------|--------|---------|--------|---------------|-------|---------|
| 28-3/8 | 18-1/4 | 30-1/2 | 12"/12"/30" | 109 lb | 11.8 ft | WL | ? | 0102 | ???? | T | \$1,456 |
| 28-3/8 | 18-1/4 | 30-1/2 | 6"/6"/12"/30" | 119 lb | 11.8 ft | WL | ? | 0103 | ???? | T | \$1,545 |
| 28-3/8 | 18-1/4 | 30-1/2 | 12"/6"/6"/30" | 119 lb | 11.8 ft | WL | ? | 0104 | ???? | T | \$1,545 |

| | | | | | | | | | | | |
|------------------|---|--------------|--------------|---|---|--------------|--------------|---|---|---|---|
| Available Fronts | A | B | C | F | H | X | N | P | Q | S | Y |
|------------------|---|--------------|--------------|---|---|--------------|--------------|---|---|---|---|

TRACE Freestanding Multidrawer FileCenter With Laminate Top



12-12-30



6-6-12-30

- Structurally identical to work surface supporting multi-drawer FileCenter
- Safety interlock and counterweight ensure stability, and are included
- Please specify laminate and edge band selection after the cabinet color

| H | D | W | Cabinet Style | Pkg Wt | Pkg Cube | Part # | Front # | Part # | Metal Color # | Lam/Edge # | Price |
|----|--------|--------|---------------|--------|----------|--------|---------|--------|---------------|------------|---------|
| 29 | 18-1/4 | 30-1/2 | 12"/12"/30" | 109 lb | 11.8 ft | WL | ? | 0102 | ???? | ???? | \$1,927 |
| 29 | 18-1/4 | 30-1/2 | 6"/6"/12"/30" | 119 lb | 11.8 ft | WL | ? | 0103 | ???? | ???? | \$2,001 |
| 29 | 18-1/4 | 30-1/2 | 12"/6"/6"/30" | 119 lb | 11.8 ft | WL | ? | 0104 | ???? | ???? | \$2,001 |

| | | | | | | | | | | | |
|------------------|---|--------------|--------------|---|---|--------------|--------------|---|---|---|---|
| Available Fronts | A | B | C | F | H | X | N | P | Q | S | Y |
|------------------|---|--------------|--------------|---|---|--------------|--------------|---|---|---|---|

SEE PAGE 2 FOR COLORS, LAMINATES, FABRICS

Recessed Front Lateral File

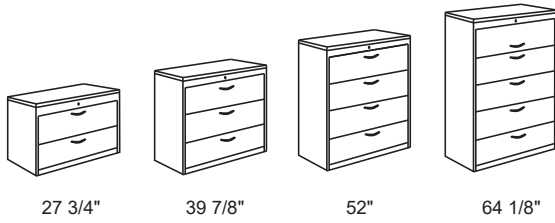

Recessed heights are different from the TRACE product line

This lateral file is not included in the TRACE collection of products because the fronts are not full-width and the finish heights, base height, and drawer front heights are not consistent with those of the TRACE products.

- Full extension slides, safety interlock included
- Counterweight required if not ganged together or otherwise anchored
- 5-high lateral includes top flipper door that recedes into the cabinet, with roll-out shelf
- Includes UM Series lock (for other lock options, see the Specification Guide in the front of this book)
- Four leveling glides with 7/8" adjustment are included to ensure proper drawer front alignment and operation

| H | D | W | Drawer Options | Pkg Wt | Pkg Cube | Part # | Front # | Part # | Metal Color # | Price |
|--------|--------|----|----------------|--------|----------|--------|---------|--------|---------------|---------|
| 27-3/4 | 17-3/8 | 30 | 2 drawer | 93 lb | 11.8 ft | RG | ? | 0101 | ???? | \$937 |
| 27-3/4 | 17-3/8 | 36 | 2 drawer | 108 lb | 14.0 ft | RG | ? | 0201 | ???? | \$1,041 |
| 27-3/4 | 17-3/8 | 42 | 2 drawer | 123 lb | 16.2 ft | RG | ? | 0301 | ???? | \$1,138 |
| 39-7/8 | 17-3/8 | 30 | 3 drawer | 129 lb | 16.5 ft | RG | ? | 0402 | ???? | \$1,230 |
| 39-7/8 | 17-3/8 | 36 | 3 drawer | 150 lb | 19.6 ft | RG | ? | 0502 | ???? | \$1,360 |
| 39-7/8 | 17-3/8 | 42 | 3 drawer | 171 lb | 22.7 ft | RG | ? | 0602 | ???? | \$1,484 |
| 52 | 17-3/8 | 30 | 4 drawer | 166 lb | 21.3 ft | RG | ? | 0703 | ???? | \$1,519 |
| 52 | 17-3/8 | 36 | 4 drawer | 192 lb | 25.2 ft | RG | ? | 0803 | ???? | \$1,675 |
| 52 | 17-3/8 | 42 | 4 drawer | 218 lb | 29.1 ft | RG | ? | 0903 | ???? | \$1,826 |
| 64-1/8 | 17-3/8 | 30 | 5 drawer | 202 lb | 26.0 ft | RG | ? | 1004 | ???? | \$1,987 |
| 64-1/8 | 17-3/8 | 36 | 5 drawer | 235 lb | 31.0 ft | RG | ? | 1104 | ???? | \$2,200 |
| 64-1/8 | 17-3/8 | 42 | 5 drawer | 268 lb | 35.6 ft | RG | ? | 1204 | ???? | \$2,411 |

Available Fronts | A | B | D | F | H | I | N | P | Q | S | Y

Recessed Front Lateral Files Counterweight – Factory Installed

- In order to satisfy ANSI-BIFMA standards for stability, counterweights are required for all lateral files that include roll-out drawers or shelves if they are not ganged together or otherwise tethered
- Fixed shelf lateral files do not require counterweights, nor do lateral files that are anchored to a wall or ganged together. See specific lateral file descriptions to determine counterweight requirements

| Description | Part # | Price |
|---------------|---|-------|
| 2 drawer c-wt | Add a "W" suffix to the lateral file product number | \$152 |
| 3 drawer c-wt | | \$120 |
| 4 drawer c-wt | | \$87 |
| 5 drawer c-wt | | \$57 |

Recessed Front Lateral Files Counterweight – Sold Separately

- These counterweights are shipped separately to be installed at the work site
- In order to satisfy ANSI-BIFMA standards for stability, counterweights are required for all lateral files that include roll-out drawers or shelves if they are not ganged together or otherwise tethered
- Fixed shelf lateral files do not require counterweights, nor do lateral files that are anchored to a wall or ganged together. See specific lateral file descriptions to determine counterweight requirements

| Description | Pkg Wt | Pkg Cube | Part # | Price |
|---------------|---------|----------|------------|-------|
| 2 drawer c-wt | 42 lb | .7 ft | SME 220019 | \$208 |
| 3 drawer c-wt | 31.5 lb | .7 ft | SME 230019 | \$177 |
| 4 drawer c-wt | 21 lb | .6 ft | SME 240019 | \$120 |
| 5 drawer c-wt | 10.5 lb | .6 ft | SME 250019 | \$73 |

Recessed Lateral File Ganging Kit



- Rather than install a counterweight, an alternate method of ensuring lateral file stability is to gang two or more laterals together side-by-side
- Ganging kit includes a drill template, screws, and instructions for attaching two laterals together

| Description | Pkg Wt | Pkg Cube | Part # | Price |
|-------------------------------|--------|----------|-------------|-------|
| Kit to gang laterals together | 1 lb | .2 ft | LME 100010K | \$45 |

SEE PAGE 2 FOR COLORS, LAMINATES, FABRICS

12" Receding Door Lateral File with Roll-Out Shelves

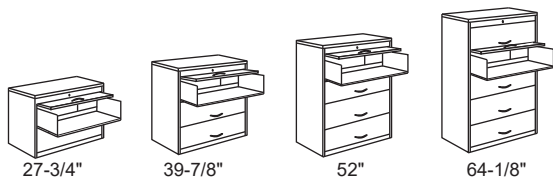

This lateral is not included in the TRACE collection of products because the fronts are not full-width and the finish heights, base height, and drawer front heights are not consistent with those of the TRACE products.

- All doors flip-up and recede inside the cabinet
- All roll-out shelves
- 10" inside clear height, 15-3/4" inside clear depth
- Full extension slides, safety interlock included
- Counterweight is required if not ganged together or otherwise anchored
- Includes UM Series lock
- Four leveling glides with 7/8" adjustment are included to ensure proper drawer alignment and operation

15" Receding Door Lateral File with Fixed Shelves

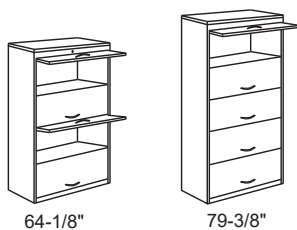

This lateral is not included in the TRACE collection of products because the fronts are not full-width and the finish heights, base height, and drawer front heights are not consistent with those of the TRACE products.

- All doors flip-up and recede inside the cabinet
- All fixed shelves
- 13" inside clear height, 15-3/4" inside clear depth
- No counterweight is necessary
- Includes UM Series lock
- Four leveling glides with 7/8" adjustment are included to ensure proper drawer alignment and operation

Recessed Front Individual-Locking Drawer Lateral File



- Any standard 2, 3, and 4-high lateral file with all 12" drawers may be upgraded to include individual security locks on each drawer
- Non-UM Series high security lock is double-bit, and captures drawer fronts on both sides
- Does not include security pan between drawers
- Does not include standard gang lock, but does include safety interlock
- Please contact Customer Service to discuss key series availability and lead time.

| H | D | W | Drawer Options | Pkg Wt | Pkg Cube | Part # | Front # | Part # | Metal Color # | Price |
|--------|--------|----|----------------|--------|----------|--------|---------|--------|---------------|---------|
| 27-3/4 | 17-3/8 | 30 | 2 drawer | 82 lb | 11.8 ft | RG | ? | 0142 | ???? | \$1,258 |
| 27-3/4 | 17-3/8 | 36 | 2 drawer | 104 lb | 14.0 ft | RG | ? | 0242 | ???? | \$1,466 |
| 27-3/4 | 17-3/8 | 42 | 2 drawer | 118 lb | 16.2 ft | RG | ? | 0342 | ???? | \$1,643 |
| 39-7/8 | 17-3/8 | 30 | 3 drawer | 96 lb | 16.5 ft | RG | ? | 0443 | ???? | \$1,770 |
| 39-7/8 | 17-3/8 | 36 | 3 drawer | 127 lb | 19.6 ft | RG | ? | 0543 | ???? | \$1,999 |
| 39-7/8 | 17-3/8 | 42 | 3 drawer | 158 lb | 22.7 ft | RG | ? | 0643 | ???? | \$2,234 |
| 52 | 17-3/8 | 30 | 4 drawer | 147 lb | 21.3 ft | RG | ? | 0744 | ???? | \$2,234 |
| 52 | 17-3/8 | 36 | 4 drawer | 171 lb | 25.2 ft | RG | ? | 0844 | ???? | \$2,539 |
| 52 | 17-3/8 | 42 | 4 drawer | 204 lb | 29.1 ft | RG | ? | 0944 | ???? | \$2,831 |
| 64-1/8 | 17-3/8 | 30 | 5 drawer | 181 lb | 26.0 ft | RG | ? | 1045 | ???? | \$2,731 |
| 64-1/8 | 17-3/8 | 36 | 5 drawer | 216 lb | 30.8 ft | RG | ? | 1145 | ???? | \$3,065 |
| 64-1/8 | 17-3/8 | 42 | 5 drawer | 238 lb | 35.6 ft | RG | ? | 1245 | ???? | \$3,421 |

Available Fronts | A | ~~B~~ | D | F | ~~H~~ | I | N | P | Q | S | Y

| H | D | W | Cabinet Style | Pkg Wt | Pkg Cube | Part # | Front # | Part # | Metal Color # | Price |
|--------|--------|----|---------------|--------|----------|--------|---------|--------|---------------|---------|
| 64-1/8 | 17-3/8 | 30 | 4 door | 178 lb | 26.0 ft | RG | ? | 1049 | ???? | \$1,707 |
| 64-1/8 | 17-3/8 | 36 | 4 door | 213 lb | 30.8 ft | RG | ? | 1149 | ???? | \$1,899 |
| 64-1/8 | 17-3/8 | 42 | 4 door | 228 lb | 35.6 ft | RG | ? | 1249 | ???? | \$2,091 |
| 79-3/8 | 17-3/8 | 30 | 5 door | 186 lb | 26.0 ft | RG | ? | 1650 | ???? | \$2,098 |
| 79-3/8 | 17-3/8 | 36 | 5 door | 220 lb | 37.7 ft | RG | ? | 1750 | ???? | \$2,334 |
| 79-3/8 | 17-3/8 | 42 | 5 door | 238 lb | 43.6 ft | RG | ? | 1850 | ???? | \$2,568 |

Available Fronts | A | ~~B~~ | ~~D~~ | F | ~~H~~ | ~~I~~ | ~~N~~ | P | Q | S | Y

Part #

Price Per Drawer

Add an "RY" as a suffix to the lateral product number
 Add this price to the list price per drawer of the standard lateral file \$70

Available Fronts | A | B | D | F | H | I | N | P | Q | S | Y

SEE PAGE 2 FOR COLORS, LAMINATES, FABRICS

**Recessed Front Lateral:
Individual Laminate Tops**



- Factory installed or shipped separately
- When factory installed, list price shown will be added to the accompanying lateral price
- Metal top is not included when using a laminate top
- Finish height of lateral file will be 5/8" taller than the height of a standard Trace lateral file with metal top
- Specify any standard GO laminate and edge. Special order laminates may require an up-charge; call for details
- Laminate tops used on individual lateral files are sized to be flush with the sides of the lateral, so that individual laterals installed side-by-side will have no gaps between

| Description | W | D | Part # | Laminate # | Price |
|------------------------|----|--------|---|------------|-------|
| Factory installed | 30 | 17-7/8 | Add laminate color number as a suffix to the lateral product number | ???? | \$344 |
| | 36 | 17-7/8 | | ???? | \$385 |
| | 42 | 17-7/8 | | ???? | \$427 |
| top shipped separately | 30 | 17-7/8 | SLEX030 | ???? | \$413 |
| | 36 | 17-7/8 | SLEX036 | ???? | \$462 |
| | 42 | 17-7/8 | SLEX042 | ???? | \$512 |

**Common Laminate Tops for
Recessed Lateral**

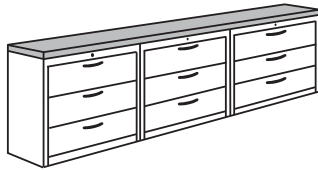

- Laminate tops ordered separately for field installation
- Specify any standard GO laminate or special ordered laminate
- Note that these tops will fit ONLY recessed lateral files
- Top sizes allow for 1/8" overhang on all sides

| | W | D | Pkg Wt | Pkg Cube | Part # | Price |
|-------------------------------------|---------|--------|--------|----------|---------|---------|
| Two Laterals Side-by-Side: | | | | | | |
| (2) 30" laterals | 60-1/4 | 17-5/8 | 37 lb | .8 ft | LL1760 | \$467 |
| (1) 30" & (1) 36" lateral | 66-1/4 | 17-5/8 | 41 lb | .9 ft | LL1766 | \$509 |
| (2) 36" laterals | 72-1/4 | 17-5/8 | 45 lb | 1.0 ft | LL1772 | \$550 |
| (2) 42" laterals | 84-1/4 | 17-5/8 | 52 lb | 1.1 ft | LL1784 | \$602 |
| Three Laterals Side-by-Side: | | | | | | |
| (3) 30" laterals | 90-1/4 | 17-5/8 | 56 lb | 1.2 ft | LL1790 | \$607 |
| (3) 36" laterals | 108-1/4 | 17-5/8 | 67 lb | 1.4 ft | LL17108 | \$785 |
| (3) 42" laterals | 126-1/4 | 17-5/8 | 78 lb | 1.7 ft | LL17126 | \$985 |
| Two Laterals Back -to-Back: | | | | | | |
| (2) 30" laterals | 30-1/4 | 35 | 37 lb | .8 ft | LL 3530 | \$490 |
| (2) 36" laterals | 36-1/4 | 35 | 45 lb | 1.0 ft | LL 3536 | \$593 |
| (2) 42" laterals | 42-1/4 | 35 | 52 lb | 1.1 ft | LL 3542 | \$598 |
| Four Laterals in Quads: | | | | | | |
| (4) 30" laterals | 60-1/4 | 35 | 74 lb | 1.6 ft | LL 3560 | \$788 |
| (4) 36" laterals | 72-1/4 | 35 | 88 lb | 1.9 ft | LL 3572 | \$973 |
| (4) 42" laterals | 84-1/4 | 35 | 103 lb | 2.2 ft | LL 3584 | \$1,025 |

SEE PAGE 2 FOR COLORS, LAMINATES, FABRICS

Magnetic Shelf Divider

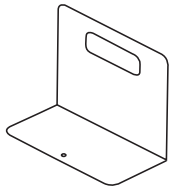

- Black magnetic dividers are 7.5" tall and 8" wide, with a 4" base. Magnet is 7-7/8" x 3"
- Appropriate for use on any lateral file drawer or shelf, bookcase, double door storage cabinet or overhead storage cabinet

| Description | Pkg Wt | Pkg Cube | Part # | Price |
|----------------|--------|----------|------------|-------|
| (package of 3) | 4.0 lb | 2 ft | LFM 300 30 | \$50 |

Magnetic Label



- Magnetic labels adhere to any metal surface to identify drawer contents
- Label dimensions are 1" high x 3" wide

| H | W | Description | Pkg Wt | Pkg Cube | Part # | Price |
|---|---|-----------------|--------|----------|--------------|-------|
| 1 | 3 | (package of 10) | .2 lb | .08 ft | TGOX 000 11K | \$37 |

Security Bar-Lock for Recessed Front Laterals

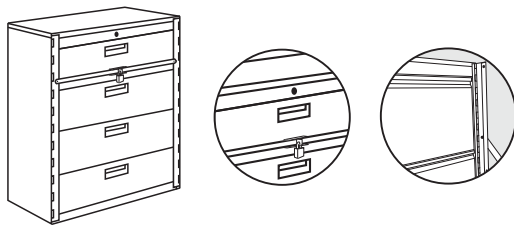

- Any standard 2, 3, 4, and 5-high recessed front lateral file with 6" or 12" drawers may be upgraded to include full-height piano hinges on each front vertical edge, with one set of hinged horizontal security bars that will accommodate a keyed or combination pad lock
- Piano hinges and horizontal bars are 11 gauge metal, and welded in place. Padlock is not included
- Bar-Lock lateral files require a 4-week lead time
- Installers must allow for at least 2" space between adjacent security laterals, so that the hinges and bar have room to be stored out of the way

| Part # | Price |
|--|---|
| Add a "BL" as a suffix to the lateral product number Add this price to the list price of the lateral file | \$502 |
| Available Fronts | A B D F H I N P Q S Y |

SEE PAGE 2 FOR COLORS, LAMINATES, FABRICS

Standard Lateral File Conversion Bar

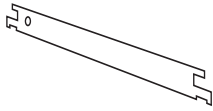

- Conversion bars allow for front-to-back filing in 18-1/4" and 17-3/8" deep lateral files. Use 2 bars each in 36" and 42" lateral drawers for legal size filing

| Description | Pkg Wt | Pkg Cube | Part # | Price |
|----------------|--------|----------|-------------|-------|
| (package of 4) | 2 lb | .8 ft | LME 4500 19 | \$27 |

"How many standard file conversion bars do I need?"

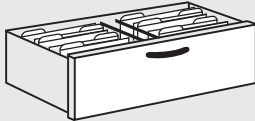

- 30" Wide Lateral**
- 2 file conversion bars per drawer
 - 15.5" x 2 rows = 31" filing space



- 36" Wide Lateral**
- 2 file conversion bars per drawer
 - 15.5" x 2 rows = 31" filing space

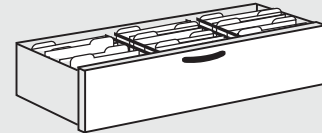

- 42" Wide Lateral**
- 4 file conversion bars per drawer
 - 15.5" x 3 rows = 46.5" filing space

Drawer Front Filler - Lateral Files

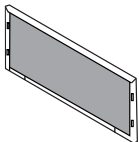

Inside View

- Lateral drawers may be upgraded to include a closed cell polyethylene filler piece that adheres to the inside of the drawer front for improved sound dampening
- Drawer Front Filler upgrades, priced per drawer, will be added to the product list price

| Descriptions | Pkg Wt | Pkg Cube | Part # | Price Per Drawer |
|------------------|--------|----------|---|------------------|
| Price per drawer | 2 lb | .8 ft | Add a "U" as a suffix to the product number | \$60 |

Available Fronts | A | B | ~~C~~ | ~~D~~ | ~~E~~ | ~~F~~ | ~~G~~ | N | P | Q | S | Y

Felt Drawer Liner



- 1/8" thick felt material is precision cut to fit inside any Cayenne or Trace lateral file drawer

| D | W | Description | Pkg Wt | Pkg Cube | Part # | Price |
|----|--------|--------------------------|--------|----------|----------|-------|
| 16 | 26-1/2 | pkg of 1 liner, 30" drw | 4 lb | 1.2 ft | FLT 0130 | \$35 |
| 16 | 32-1/2 | pkg of 1 liner, 36" drw | 4 lb | 1.2 ft | FLT 0136 | \$35 |
| 16 | 38-1/2 | pkg of 1 liner, 42" drw | 4 lb | 1.2 ft | FLT 0142 | \$35 |
| 16 | 26-1/2 | pkg of 5 liners, 30" drw | 20 lb | 1.6 ft | FLT 0530 | \$148 |
| 16 | 32-1/2 | pkg of 5 liners, 36" drw | 20 lb | 1.6 ft | FLT 0536 | \$148 |
| 16 | 38-1/2 | pkg of 5 liners, 42" drw | 20 lb | 1.6 ft | FLT 0542 | \$148 |

Magnetic Drawer Dividers - 6" Drawer



- Dividers fit inside 6" lateral drawer bins to create sectioned drawer space
- 16" depth divider fits front-to-back in drawer bin, painted black
- Magnets attach to front and back of drawer bin, and will work in conjunction with Felt Drawer Liners (above)

| Description | Pkg Wt | Pkg Cube | Part # | Price |
|------------------------------|--------|----------|------------|-------|
| Pkg of (4) 16" x 4" dividers | 22 lb | 1.8 ft | LFM 40042K | \$88 |

SEE PAGE 2 FOR COLORS, LAMINATES, FABRICS

TRACE towers feature horizontal lines and full-width fronts consistent with all other TRACE products.

Basic Construction

- All Great Openings products meet or exceed applicable ANSI-BIFMA standards for durability and safety
- A lifetime warranty ensures long-lasting performance and after-sale support
- Steel frame construction is welded and channels are formed in key areas for strength
- Top, back, side, and center panels are 21 gauge metal
- Inner top, bottom, and side channels are 18 gauge steel, drawer and door fronts are 20-22 gauge steel
- Shelves are 18 gauge steel, and drawer bins are 22 gauge. Bottom pan is 16 gauge steel

For Your Safety

- Casters, when included, are two locking and two non-locking
- Towers include a safety interlock that allows only one drawer to open at a time

Features

- Shelves are adjustable in 1-1/2" increments
- Cupboard shelf load capacity is 61 lbs
- All drawers include full-extension steel ball-bearing slides
- Slides include "anti-rebound" and "quick disconnect" features
- File drawer dividers allow for side-to-side filing, and are sold separately
- All cupboard and coat doors include concealed hinges that allow for 110° opening

Lock System

- All towers include either one or two locks. See specific product specs for details
- Locks are randomly-assigned UM Series (#226-425)
- UM locks are black-faced, master-keyed, and core-removable, and may be keyed-alike in the field
- Other key series are available, including Haworth SL, bright nickel LL, and Knoll K. Please see the Specification Guide in the front of this book

Options and Accessories:

- 6" drawer dividers, 12" drawer dividers that allow for side-to-side filing, and pencil trays
- Fronts are mechanically fastened and removable to maximize design flexibility
- Laminate fronts are available for cupboard wardrobe towers. See the Specification Guide in the front of this book
- Work surface support bracket attaches to bookcase wardrobe and pedestal towers with side bookcase
- Wardrobe dome top may be added to any 23-1/2" x 23-1/2" wardrobe tower
- Magnetic shelf divider, sold in packages of three, available as shelf or drawer dividers

Can I Customize?

Towers and lockers with special heights, widths, depths, and drawer/cupboard configurations are one of our specialties! Call for details.



| Product Style | | Inner Clear Height (in.) | Inner Clear Width (in.) | Inner Clear Depth (in.) |
|-------------------------|--------------------------------|--------------------------|-------------------------|-------------------------|
| Cupboard Wardrobe Tower | Coat closet in 65-7/8" tower | 61.070 | 6.000 | 22.750 |
| | Coat closet 51-3/8" tower | 46.575 | 6.000 | 22.750 |
| | Cupboard in 65-7/8" tower | 37.250 | 12.500 | 22.750 |
| | Cupboard in 51-3/8" tower | 22.800 | 12.500 | 22.750 |
| | Box drawer | 4.500 | 12.125 | 18.810 |
| | File drawer | 9.500 | 12.125 | 18.250 |
| | Adjustable shelf thickness | 1.000 | - | - |
| Cupboard Tower | Cupboard in 65-7/8" tower | 37.250 | 12.500 | 22.750 |
| | Cupboard in 51-3/8" high tower | 22.800 | 12.500 | 22.750 |
| | Adjustable shelf thickness | 1.000 | - | - |
| Bookcase Wardrobe Tower | Coat closet in 65-7/8" tower | 61.070 | 6.000 | 22.750 |
| | Coat closet in 51-3/8" tower | 46.570 | 6.000 | 22.750 |
| | Bookcase in 65-7/8" tower | 21.500 | 21.500 | 15.000 |
| | Bookcase in 51-3/8" tower | 36.000 | 21.500 | 15.000 |
| | Box drawer | 4.500 | 12.125 | 18.810 |
| | File drawer | 9.500 | 12.125 | 18.250 |
| | Adjustable shelf thickness | 1.000 | - | - |
| Bookcase Tower | Bookcase in 65-7/8" tower | 36.000 | 21.500 | 15.000 |
| | Bookcase in 51-3/8" tower | 21.500 | 21.500 | 15.000 |
| | Box drawer | 4.500 | 12.125 | 18.810 |
| | File drawer | 9.500 | 12.125 | 18.250 |
| | Adjustable shelf thickness | 1.000 | - | - |

SEE PAGE 2 FOR COLORS, LAMINATES, FABRICS

**TRACE Cupboard
Wardrobe Tower**



39-7/8"
Coat Right



65-7/8"
Coat Left

- Single lock captures all doors and drawers
- Coat closet includes side-to-side coat rod
- 39" tower: no adjustable shelf
- 46" tower: no adjustable shelf
- 51-3/8" tower w/ 24.5" cupboard: one adjustable shelf
- 51-3/8" tower w/ 13" cupboard: no adjustable shelf
- 56" tower: one adjustable shelf
- 65-7/8" tower w/ 39" cupboard: two adjustable shelves
- 65-7/8" tower w/ 27" cupboard: one adjustable shelf
- Leveling glides allow for 7/8" adjustment
- Pedestal height is 27-3/4"

| H | D | W | Coat Door | Drawer Options | Pkg Wt | Pkg Cube | Part # | Front Style | Part # | Metal Color | Price |
|--------|--------|--------|-----------|-------------------------------------|--------|----------|--------|-------------|--------|-------------|---------|
| 39-7/8 | 23-1/2 | 23-1/2 | left | 2 file drawers, 13" cupboard | 136 lb | 18.0 ft | DG | ? | A354 | ???? | \$1,982 |
| | | | left | 2 box/1 file drawer, 13" cupboard | 139 lb | 18.0 ft | DG | ? | A338 | ???? | \$2,019 |
| 39-7/8 | 23-1/2 | 23-1/2 | right | 2 file drawers, 13" cupboard | 136 lb | 18.0 ft | WG | ? | A354 | ???? | \$1,982 |
| | | | right | 2 box/1 file drawer, 13" cupboard | 139 lb | 18.0 ft | WG | ? | A338 | ???? | \$2,019 |
| 46 | 23-1/2 | 23-1/2 | left | 2 file drawers, 19" cupboard | 150 lb | 19.5 ft | DG | ? | 4454 | ???? | \$2,032 |
| | | | left | 2 box/1 file drawer, 19" cupboard | 153 lb | 19.5 ft | DG | ? | 4472 | ???? | \$2,157 |
| 46 | 23-1/2 | 23-1/2 | right | 2 file drawers, 19" cupboard | 150 lb | 19.5 ft | WG | ? | 4454 | ???? | \$2,032 |
| | | | right | 2 box/1 file drawer, 19" cupboard | 153 lb | 19.5 ft | WG | ? | 4472 | ???? | \$2,157 |
| 51-3/8 | 23-1/2 | 23-1/2 | left | 2 file drawers, 24.5" cupboard | 164 lb | 21.0 ft | DG | ? | J654 | ???? | \$2,081 |
| | | | left | 2 box/1 file drawer, 24.5" cupboard | 167 lb | 21.0 ft | DG | ? | J672 | ???? | \$2,158 |
| | | | left | 3 file drawers, 13" cupboard | 175 lb | 21.0 ft | DG | ? | J652 | ???? | \$2,222 |
| 51-3/8 | 23-1/2 | 23-1/2 | right | 2 file drawers, 24.5" cupboard | 164 lb | 21.0 ft | WG | ? | J654 | ???? | \$2,081 |
| | | | right | 2 box/1 file drawer, 24.5" cupboard | 167 lb | 21.0 ft | WG | ? | J672 | ???? | \$2,158 |
| | | | right | 3 file drawers, 13" cupboard | 175 lb | 21.0 ft | WG | ? | J652 | ???? | \$2,222 |
| 56 | 23-1/2 | 23-1/2 | left | 2 file drawers, 29" cupboard | 178 lb | 23 ft | DG | ? | A754 | ???? | \$2,088 |
| | | | left | 2 box/1 file drawer, 29" cupboard | 181 lb | 23 ft | DG | ? | A772 | ???? | \$2,235 |
| 56 | 23-1/2 | 23-1/2 | right | 2 file drawers, 29" cupboard | 178 lb | 23 ft | WG | ? | A754 | ???? | \$2,088 |
| | | | right | 2 box/1 file drawer, 29" cupboard | 181 lb | 23 ft | WG | ? | A772 | ???? | \$2,235 |
| 65-7/8 | 23-1/2 | 23-1/2 | left | 2 file drawers, 39" cupboard | 193 lb | 25.7 ft | DG | ? | C254 | ???? | \$2,234 |
| | | | left | 2 box/1 file drawer, 39" cupboard | 195 lb | 25.7 ft | DG | ? | C272 | ???? | \$2,312 |
| | | | left | 3 file drawers, 27" cupboard | 195 lb | 25.7 ft | DG | ? | C252 | ???? | \$2,312 |
| | | | left | 2 box/2 file drawers, 27" cupboard | 197 lb | 25.7 ft | DG | ? | C258 | ???? | \$2,388 |
| 65-7/8 | 23-1/2 | 23-1/2 | right | 2 file drawers, 39" cupboard | 193 lb | 25.7 ft | WG | ? | C254 | ???? | \$2,234 |
| | | | right | 2 box/1 file drawer, 39" cupboard | 195 lb | 25.7 ft | WG | ? | C272 | ???? | \$2,312 |
| | | | right | 3 file drawers, 27" cupboard | 195 lb | 25.7 ft | WG | ? | C252 | ???? | \$2,312 |
| | | | right | 2 box/2 file drawers, 27" cupboard | 197 lb | 25.7 ft | WG | ? | C258 | ???? | \$2,388 |

Available Fronts | A | ~~B~~ | D | F | ~~G~~ | ~~H~~ | ~~I~~ | N | ~~P~~ | Q | S | Y

**TRACE Mobile Cupboard
Wardrobe Tower**



43-1/4"
Coat Left

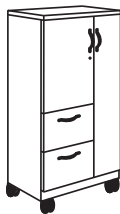

54-3/4"
Coat Right

- Features are identical to tower described above
- Black 75mm casters: (2) locking and (2) non-locking
- Height listed includes casters (approximately 3")
- 43-1/4" tower: no adjustable shelf
- 54-3/4" tower: one adjustable shelf

| H | D | W | Coat Door | Drawer Options | Caster | Pkg Wt | Pkg Cube | Part # | Front Style | Part # | Metal Color | Price |
|--------|--------|--------|-----------|----------------|--------|--------|----------|--------|-------------|--------|-------------|---------|
| 43-1/4 | 23-1/2 | 23-1/2 | left | file/file | black | 170 lb | 21.0 ft | DG | ? | 9954 | ???? | \$2,168 |
| | | | right | file/file | black | 170 lb | 21.0 ft | WG | ? | 9954 | ???? | \$2,168 |
| 54-3/4 | 23-1/2 | 23-1/2 | left | file/file | black | 170 lb | 21.0 ft | DG | ? | J854 | ???? | \$2,362 |
| | | | right | file/file | black | 170 lb | 21.0 ft | WG | ? | J854 | ???? | \$2,362 |

Available Fronts | A | ~~B~~ | D | F | ~~G~~ | ~~H~~ | ~~I~~ | N | ~~P~~ | Q | S | Y

Wardrobe Dome Top



- Metal dome fits any 23-1/2" x 23-1/2" tower
- Factory installed
- Adds 5" to finish height of tower
- Also available with translucent acrylic insert (TL)
- This accessory price will be added to tower price

| Options | Product # | Price |
|---------|---|-------|
| metal | add a "DT" as a suffix to the product number. | \$380 |

- Because the dome top carries a square front vertical edge, it is not recommended for use on cabinets that include radiused door and drawer fronts
- Towers ordered with dome tops require a three week lead time

SEE PAGE 2 FOR COLORS, LAMINATES, FABRICS

TRACE Cupboard Tower

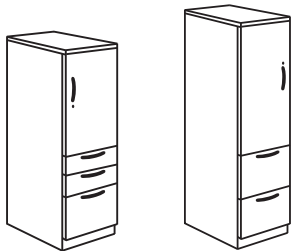

51-3/8"
Hinge Right

65-7/8"
Hinge Left

- Single lock captures cupboard and drawers
- 46" tower: no adjustable shelf
- 51-3/8" tower: one adjustable shelf
- 56" tower: one adjustable shelf
- 65-7/8" tower: two adjustable shelves
- Leveling glides allow for 7/8" adjustment
- Will not accommodate work surface support bracket
- Not available with individually locking drawers

| H | D | W | Hinge Location | Drawer Options | Pkg Wt | Pkg Cube | Part # | Front Style | Part # | Metal Color | Price |
|--------|--------|--------|----------------|------------------------------|--------|----------|--------|-------------|--------|-------------|---------|
| 46 | 23-1/2 | 15-1/4 | left | file/file 19.2" cupboard | 81 lb | 11 ft | CL | ? | N309 | ???? | \$1,243 |
| | | | right | file/file 19.2" cupboard | 81 lb | 11 ft | CR | ? | N309 | ???? | \$1,243 |
| 46 | 23-1/2 | 15-1/4 | left | box/box/file 19.2" cupboard | 83 lb | 11 ft | CL | ? | N3111 | ???? | \$1,368 |
| | | | right | box/box/file 19.2" cupboard | 83 lb | 11 ft | CR | ? | N3111 | ???? | \$1,368 |
| 51-3/8 | 23-1/2 | 15-1/4 | left | file/file 24.5" cupboard | 85 lb | 14.2 ft | CL | ? | K409 | ???? | \$1,271 |
| | | | right | file/file 24.5" cupboard | 85 lb | 14.2 ft | CR | ? | K409 | ???? | \$1,271 |
| 51-3/8 | 23-1/2 | 15-1/4 | left | box/box/file 24.5" cupboard | 87 lb | 14.2 ft | CL | ? | K411 | ???? | \$1,396 |
| | | | right | box/box/file 24.5" cupboard | 87 lb | 14.2 ft | CR | ? | K411 | ???? | \$1,396 |
| 56 | 23-1/2 | 15-1/4 | left | file/file 31.75" cupboard | 88 lb | 15.4 ft | CL | ? | N209 | ???? | \$1,301 |
| | | | right | file/file 31.75" cupboard | 88 lb | 15.4 ft | CR | ? | N209 | ???? | \$1,301 |
| 56 | 23-1/2 | 15-1/4 | left | box/box/file 31.75" cupboard | 91 lb | 15.8 ft | CL | ? | N211 | ???? | \$1,425 |
| | | | right | box/box/file 31.75" cupboard | 91 lb | 15.8 ft | CR | ? | N211 | ???? | \$1,425 |
| 65-7/8 | 23-1/2 | 15-1/4 | left | file/file 39" cupboard | 93 lb | 17.3 ft | CL | ? | K309 | ???? | \$1,338 |
| | | | right | file/file 39" cupboard | 93 lb | 17.3 ft | CR | ? | K309 | ???? | \$1,338 |
| 65-7/8 | 23-1/2 | 15-1/4 | left | box/box/file 39" cupboard | 95 lb | 17.3 ft | CL | ? | K311 | ???? | \$1,463 |
| | | | right | box/box/file 39" cupboard | 95 lb | 17.3 ft | CR | ? | K311 | ???? | \$1,463 |

Available Fronts | A | ~~B~~ | D | F | ~~G~~ | ~~H~~ | N | ~~P~~ | Q | S | Y

SEE PAGE 2 FOR COLORS, LAMINATES, FABRICS

TRACE Bookcase Wardrobe Tower

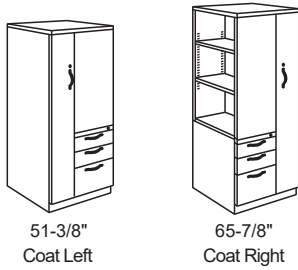

- Tower includes two locks, keyed-alike
- Coat closet includes a two-pronged coat hook
- 46" tower: no adjustable shelf
- 51-3/8" tower: one adjustable shelf
- 56" tower: one adjustable shelf
- 65-7/8" tower: two adjustable shelves
- Leveling glides allow for 1-5/8" adjustment

| H | D | W | Coat Door | Drawer Options | Pkg Wt | Pkg Cube | Part # | Front Style | Part # | Metal Color | Price |
|--------|--------|--------|-----------|----------------|--------|----------|--------|-------------|--------|-------------|---------|
| 46 | 23-1/2 | 23-1/2 | left | file/file | 145 lb | 18.4 ft | LG | ? | V709 | ???? | \$2,134 |
| | | | left | box/box/file | 148 lb | 18.4 ft | LG | ? | V711 | ???? | \$2,211 |
| 46 | 23-1/2 | 23-1/2 | right | file/file | 145 lb | 18.4 ft | MG | ? | V709 | ???? | \$2,134 |
| | | | right | box/box/file | 148 lb | 18.4 ft | MG | ? | V711 | ???? | \$2,211 |
| 51-3/8 | 23-1/2 | 23-1/2 | left | file/file | 152 lb | 21.0 ft | LG | ? | J609 | ???? | \$2,202 |
| | | | left | box/box/file | 155 lb | 21.0 ft | LG | ? | J611 | ???? | \$2,279 |
| 51-3/8 | 23-1/2 | 23-1/2 | right | file/file | 152 lb | 21.0 ft | MG | ? | J609 | ???? | \$2,202 |
| | | | right | box/box/file | 155 lb | 21.0 ft | MG | ? | J611 | ???? | \$2,279 |
| 56 | 23-1/2 | 23-1/2 | left | file/file | 159 lb | 23.4 ft | LG | ? | V609 | ???? | \$2,271 |
| | | | left | box/box/file | 162 lb | 23.4 ft | LG | ? | V611 | ???? | \$2,347 |
| 56 | 23-1/2 | 23-1/2 | right | file/file | 159 lb | 23.4 ft | MG | ? | V609 | ???? | \$2,271 |
| | | | right | box/box/file | 162 lb | 23.4 ft | MG | ? | V611 | ???? | \$2,347 |
| 65-7/8 | 23-1/2 | 23-1/2 | left | file/file | 166 lb | 25.7 ft | LG | ? | C209 | ???? | \$2,395 |
| | | | left | box/box/file | 169 lb | 25.7 ft | LG | ? | C211 | ???? | \$2,471 |
| 65-7/8 | 23-1/2 | 23-1/2 | right | file/file | 166 lb | 25.7 ft | MG | ? | C209 | ???? | \$2,395 |
| | | | right | box/box/file | 169 lb | 25.7 ft | MG | ? | C211 | ???? | \$2,471 |

Available Fronts | A | ~~B~~ | D | F | ~~G~~ | ~~X~~ | N | ~~R~~ | Q | S | Y

TRACE Bookcase Tower

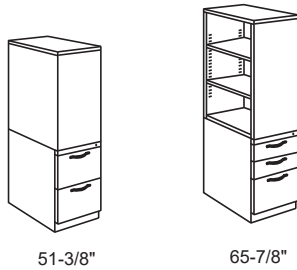

- Single lock captures all drawers
- 46" tower: no adjustable shelf
- 51-3/8" tower: one adjustable shelf
- 56" tower: one adjustable shelf
- 65-7/8" tower: two adjustable shelves
- Leveling glides allow for 1-5/8" adjustment

| H | D | W | Bookcase Facing | Drawer Options | Pkg Wt | Pkg Cube | Part # | Front Style | Part # | Metal Color | Price |
|--------|--------|--------|-----------------|----------------|--------|----------|--------|-------------|--------|-------------|---------|
| 46 | 23-1/2 | 15-1/4 | left | file/file | 82 lb | 12.5 ft | BL | ? | 4609 | ???? | \$1,202 |
| | | | left | box/box/file | 87 lb | 12.5 ft | BL | ? | 4611 | ???? | \$1,233 |
| 46 | 23-1/2 | 15-1/4 | right | file/file | 82 lb | 12.5 ft | BR | ? | 4609 | ???? | \$1,202 |
| | | | right | box/box/file | 87 lb | 12.5 ft | BR | ? | 4611 | ???? | \$1,233 |
| 51-3/8 | 23-1/2 | 15-1/4 | left | file/file | 85 lb | 14.2 ft | BL | ? | 5109 | ???? | \$1,210 |
| | | | left | box/box/file | 90 lb | 14.2 ft | BL | ? | 5111 | ???? | \$1,248 |
| 51-3/8 | 23-1/2 | 15-1/4 | right | file/file | 85 lb | 14.2 ft | BR | ? | 5109 | ???? | \$1,210 |
| | | | right | box/box/file | 90 lb | 14.2 ft | BR | ? | 5111 | ???? | \$1,248 |
| 56 | 23-1/2 | 15-1/4 | left | file/file | 87 lb | 15.6 ft | BL | ? | 5609 | ???? | \$1,219 |
| | | | left | box/box/file | 93 lb | 15.6 ft | BL | ? | 5611 | ???? | \$1,262 |
| 56 | 23-1/2 | 15-1/4 | right | file/file | 87 lb | 15.6 ft | BR | ? | 5609 | ???? | \$1,219 |
| | | | right | box/box/file | 93 lb | 15.6 ft | BR | ? | 5611 | ???? | \$1,262 |
| 65-7/8 | 23-1/2 | 15-1/4 | left | file/file | 90 lb | 17.3 ft | BL | ? | 6509 | ???? | \$1,235 |
| | | | left | box/box/file | 95 lb | 17.3 ft | BL | ? | 6511 | ???? | \$1,288 |
| 65-7/8 | 23-1/2 | 15-1/4 | right | file/file | 90 lb | 17.3 ft | BR | ? | 6509 | ???? | \$1,235 |
| | | | right | box/box/file | 95 lb | 17.3 ft | BR | ? | 6511 | ???? | \$1,288 |

Available Fronts | A | ~~B~~ | D | F | ~~G~~ | ~~X~~ | N | ~~R~~ | Q | S | Y

Work Surface Supporting Bracket

- May be added to any bookcase wardrobe tower or bookcase tower with side bookcase
- May not be used on cupboard tower
- Factory installed only
- Supports 1-1/4" work surface at 27-3/4" finish height
- Black bracket is 17" wide, extends 3"
- Three mounting holes for work surface attachment
- Modesty panel not available for this application

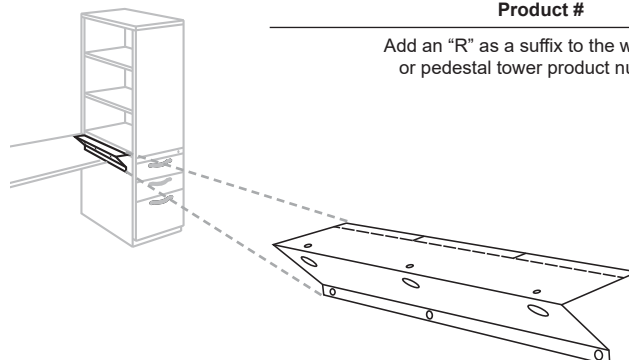

| Product # | Price |
|--|-------|
| Add an "R" as a suffix to the wardrobe or pedestal tower product number. | \$64 |

SEE PAGE 2 FOR COLORS, LAMINATES

Lock Options

All Great Openings lockers may be specified with either keyed locks or electronic locks.

Keyed Locks

Lockers come standard with randomly-assigned UM Series lockers (#226-425). UM locks are black-faced, master-keyed and core-removable. You may arrange with Customer Service to have these locks keyed-alike in the field. Other key series options are available, including bright nickel LL, Haworth SL, and the Knoll K.



Hasp Locks

Hasp locks, which are available on A: Full Pull fronts only, can be ordered for a \$50.00 list up-charge per door.



Electronic Locks

All Great Openings lockers may be specified to include electronic locks rather than keyed locks. You'll find details starting on page 9.



Interior Power Outlet

Specify a power outlet inside any locker. A multi-circuit power feed can accommodate up to 32 lockers, with plug-in power inside each locker and wires routed outside and behind the cabinets. Single door lockers, the power outlets are horizontal and Cubby door lockers, the outlets are vertical (see illustration to the right). Contact Sales for specification assistance and pricing.

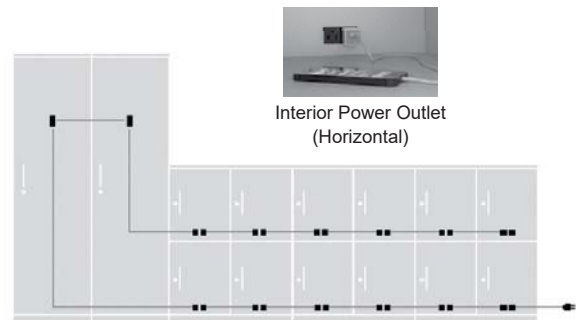

Three Locker Door Options

Order your lockers with one of three door options: metal fronts (painted either the same color as the cabinet or a contrasting color), high-pressure laminate (HPL) fronts, or thermal-fused laminate (TFL).

You'll find a form on our website to help you specify and price multiple colored locker fronts. Look for the "Multiple Locker Color Fronts" form in the Locker product section.



Can I Customize?

Lockers with special heights, widths and depths are one of our specialties!

Minimum quantities are required. Call Sales for details.

Features

- All metal construction
- Doors may be metal, high-pressure laminate, or thermal-fused laminate
- Lockers include inner side panels, so that structural components are nicely concealed
- Metal doors may be painted different colors than the cabinet. See “Locker Multiple Color Fronts” on our website for instructions on how to specify
- 18” deep lockers include (2) two-pronged coat hooks, one per side
- 24” deep lockers include (1) side-to-side coat rod, located just beneath the shelf. There’s one exception to this: 39 7/8” high single door lockers that are 24” deep include (2) coat hooks rather than a coat rod. This is because the relatively short height of the locker makes a coat rod impractical.
- Additional adjustable shelves are available for order
- Door may hinge left or right
- Interior power outlets may be installed inside locker compartments. Call Sales for specification and pricing.
- Lockers available with three lock options: keyed (UM is standard, and also available with LL, SL, or K series lockers), electronic locks, and hasp lock
- Conventional keyed lockers are keyed randomly at the factory. Key alike service is available.
- Accessories include (see page 16)
 - Locker ganging kit, to hold two or more lockers snug together when installed side-to-side
 - Common laminate tops
 - Door number plates, to permanently identify individual locker doors

Basic Construction

- All Great Openings products meet or exceed applicable ANSI-BIFMA standards for durability and safety
- A life time warranty ensures long-lasting performance and after-sale support
- All-welded 18 – 21 gauge steel construction
- Leveling glides allow for 7/8” adjustment and are accessible from inside the locker
- Concealed door hinges allow for 100 degree opening

Create your own door color combinations.

Visit our website (or click [here](#)) to view the details.



SEE PAGE 2 FOR COLORS, LAMINATES

Inside Locker Dimensions

| Product Style | | Inner Height (in.) | Inner Width (in.) | Inner Depth (in.) |
|----------------------------------|---------------------------------|--------------------|-------------------|-------------------|
| 12" Wide Single Locker, 18" Deep | 39-7/8" high locker | 44.000 | 10.580 | 17.156 |
| | 51-3/8" high locker Above shelf | 47.375 12.000 | 10.580 | 17.156 |
| | 65-7/8" high locker Above shelf | 61.875 12.000 | 10.580 | 17.156 |
| 12" Wide Single Locker, 24" Deep | 39-7/8" high locker | 44.000 | 10.580 | 23.156 |
| | 51-3/8" high locker Above shelf | 47.375 12.000 | 10.580 | 23.156 |
| | 65-7/8" high locker Above shelf | 61.875 12.000 | 10.580 | 23.156 |
| 12" Wide Double Locker, 18" Deep | Top locker | 30.828 | 10.580 | 17.156 |
| | Bottom locker | 30.279 | 10.580 | 17.156 |
| 12" Wide Double Locker, 24" Deep | Top locker | 30.828 | 10.580 | 23.156 |
| | Bottom locker | 30.279 | 10.580 | 23.156 |
| 18" Wide Single Locker 18" Deep | 39-7/8" high locker | 44.000 | 16.580 | 17.156 |
| | 51-3/8" high locker Above shelf | 47.375 12.000 | 16.580 | 17.156 |
| | 65-7/8" high locker Above shelf | 61.875 12.000 | 16.580 | 17.156 |
| 18" Wide Single Locker 24" Deep | 39-7/8" high locker | 44.000 | 16.580 | 23.156 |
| | 51-3/8" high locker Above shelf | 47.375 12.000 | 16.580 | 23.156 |
| | 65-7/8" high locker Above shelf | 61.875 12.000 | 16.580 | 23.156 |
| 18" Wide Double Locker 18" Deep | Top locker | 30.828 | 16.580 | 17.156 |
| | Bottom locker | 30.279 | 16.580 | 17.156 |
| 18" Wide Double Locker 24" Deep | Top locker | 30.828 | 16.580 | 23.156 |
| | Bottom locker | 30.279 | 16.580 | 23.156 |
| Multi-Purpose Locker | 65-7/8" high locker | 61.875 | 16.580 | 17.156 |
| | Above shelf | 12.000 | 16.580 | 17.156 |
| Quad Locker | Top lockers | 30.828 | 10.580 | 17.156 |
| | Bottom lockers | 30.279 | 10.580 | 17.156 |
| Single Width Cubby Locker | Inside Clear Dimensions | 14.750 | 10.580 | 17.156 |
| Double Width Cubby Locker | Inside Clear Dimensions | 14.750 | 10.580 | 17.156 |
| Mobile Mini Locker | Inside Clear Dimensions | 16.250 | 8.580 | 17.406 |
| Freestanding Mini Locker | Inside Clear Dimensions | 16.250 | 8.580 | 17.406 |

SEE PAGE 2 FOR COLORS, LAMINATES

TRACE 12" Wide Single Locker

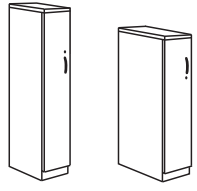

65-7/8" H
18" D
Hinge Left

51-3/8" H
24" D
Hinge Left

- 51-3/8" and 65-7/8" high lockers include one adjustable shelf on top, with up to 12" clear height above the shelf.
- 39-7/8" high lockers do not include any shelves.
- All single door lockers include two clusters of shelf clip holes in the side panels, to accommodate additional shelves that are sold separately. One cluster near the top of the locker allows for 3" adjustability, with up to 12" clear height above the shelf. A second cluster near the bottom of the locker allows for 3" adjustability, with up to 8" clear height below the shelf.
- The 18" deep lockers include (2) two-pronged coat hooks, one on each side. The 24" deep lockers include (1) side-to-side coat rod.

| H | D | W | Hinge Location | Pkg Wt | Pkg Cube | Part # | Front Style | Part # | Metal Color | Laminate | Metal Door Price | HPL Door Price | TFL Door Price |
|---|----|----|----------------|--------|----------|--------|-------------|----------|-------------|----------|------------------|----------------|----------------|
| 39-7/8 | 18 | 12 | left | 55 lb | 6.5 ft | LG | ? | 3P28 | ???? | ???? | \$977 | \$1,177 | \$1,166 |
| 39-7/8 | 18 | 12 | right | 55 lb | 6.5 ft | RG | ? | 3P28 | ???? | ???? | \$977 | \$1,177 | \$1,166 |
| 39-7/8 | 24 | 12 | left | 66 lb | 8.8 ft | LG | ? | 8P28 | ???? | ???? | \$994 | \$1,210 | \$1,199 |
| 39-7/8 | 24 | 12 | right | 66 lb | 8.8 ft | RG | ? | 8P28 | ???? | ???? | \$994 | \$1,210 | \$1,199 |
| 51-3/8 | 18 | 12 | left | 69 lb | 8.24 ft | LG | ? | 7M28 | ???? | ???? | \$1,185 | \$1,406 | \$1,345 |
| 51-3/8 | 18 | 12 | right | 69 lb | 8.24 ft | RG | ? | 7M28 | ???? | ???? | \$1,185 | \$1,406 | \$1,345 |
| 51-3/8 | 24 | 12 | left | 83 lb | 11 ft | LG | ? | 6M28 | ???? | ???? | \$1,240 | \$1,461 | \$1,400 |
| 51-3/8 | 24 | 12 | right | 83 lb | 11 ft | RG | ? | 6M28 | ???? | ???? | \$1,240 | \$1,461 | \$1,400 |
| 65-7/8 | 18 | 12 | left | 82 lb | 11 ft | LG | ? | 1N28 | ???? | ???? | \$1,215 | \$1,555 | \$1,469 |
| 65-7/8 | 18 | 12 | right | 82 lb | 11 ft | RG | ? | 1N28 | ???? | ???? | \$1,215 | \$1,555 | \$1,469 |
| 65-7/8 | 24 | 12 | left | 100 lb | 14.3 ft | LG | ? | 9M28 | ???? | ???? | \$1,270 | \$1,610 | \$1,524 |
| 65-7/8 | 24 | 12 | right | 100 lb | 14.3 ft | RG | ? | 9M28 | ???? | ???? | \$1,270 | \$1,610 | \$1,524 |
| (2) 18d x 12w adj. metal shelves | | | | 2.5 lb | 1 ft | | | ALT21218 | ???? | | \$218 | \$218 | \$218 |
| (2) 24d x 12w adj. metal shelves | | | | 4 lb | 1.5 ft | | | ALT21224 | ???? | | \$235 | \$235 | \$235 |

Available Fronts | A | ~~B~~ | ~~C~~ | ~~D~~ | ~~E~~ | ~~F~~ | ~~G~~ | ~~H~~ | ~~I~~ | ~~J~~ | ~~K~~ | ~~L~~ | ~~M~~ | ~~N~~ | ~~O~~ | Q | S | Y

TRACE 12" Wide Double Locker

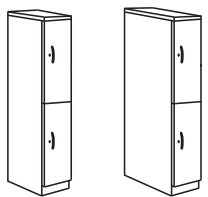

18" D
Hinge Right

24" D
Hinge Right

- Double Door lockers do not include shelves. If desired, adjustable shelves may be ordered separately.
- Both doors hinge together, either left or right
- Each locker compartment includes (2) two-pronged coat hooks, one per side
- The two locker doors are keyed randomly in the factory

| H | D | W | Hinge Location | Pkg Wt | Pkg Cube | Part # | Front Style | Part # | Metal Color | Laminate | Metal Door Price | HPL Door Price | TFL Door Price |
|---|----|----|----------------|--------|----------|--------|-------------|----------|-------------|----------|------------------|----------------|----------------|
| 65-7/8 | 18 | 12 | left | 83 lb | 11 ft | LG | ? | 3NH7 | ???? | ???? | \$1,398 | \$1,968 | \$1,866 |
| 65-7/8 | 18 | 12 | right | 83 lb | 11 ft | RG | ? | 3NH7 | ???? | ???? | \$1,398 | \$1,968 | \$1,866 |
| 65-7/8 | 24 | 12 | left | 101 lb | 14.3 ft | LG | ? | 2NH7 | ???? | ???? | \$1,453 | \$2,023 | \$1,921 |
| 65-7/8 | 24 | 12 | right | 101 lb | 14.3 ft | RG | ? | 2NH7 | ???? | ???? | \$1,453 | \$2,023 | \$1,921 |
| (2) 18d x 12w adj. metal shelves | | | | 2.5 lb | 1 ft | | | ALT21218 | ???? | | \$218 | \$218 | \$218 |
| (2) 24d x 12w adj. metal shelves | | | | 4 lb | 1 ft | | | ALT21224 | ???? | | \$235 | \$235 | \$235 |

Available Fronts | A | ~~B~~ | ~~C~~ | ~~D~~ | ~~E~~ | ~~F~~ | ~~G~~ | ~~H~~ | ~~I~~ | ~~J~~ | ~~K~~ | ~~L~~ | ~~M~~ | ~~N~~ | ~~O~~ | Q | S | Y

18" LOCKERS WITH KEYED LOCKS

SIN 711-3

SEE PAGE 2 FOR COLORS, LAMINATES

TRACE 18" Wide Single Locker

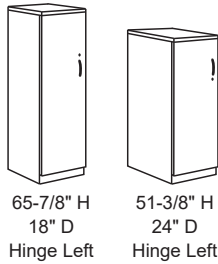

- 51-3/8" and 65-7/8" high lockers include one adjustable shelf on top, with up to 12" clear height above the shelf.
- 39-7/8" high lockers do not include any shelves.
- All single door lockers include two clusters of shelf clip holes in the side panels, to accommodate additional shelves that are sold separately. One cluster near the top of the locker allows for 3" adjustability, with up to 12" clear height above the shelf. A second cluster near the bottom of the locker allows for 3" adjustability, with up to 8" clear height below the shelf.
- The 18" deep lockers include (2) two-pronged coat hooks, one on each side. The 24" deep lockers include (1) side-to-side coat rod.

| H | D | W | Hinge Location | Pkg Wt | Pkg Cube | Part # | Front Style | Part # | Metal Color | Laminate | Metal Door Price | HPL Door Price | TFL Door Price |
|---|----|----|----------------|--------|----------|--------|-------------|--------|-------------|----------|------------------|----------------|----------------|
| 39-7/8 | 18 | 18 | left | 64 lb | 9.7 ft | LG ? | 9P28 | ???? | ???? | | \$988 | \$1,294 | \$1,220 |
| 39-7/8 | 18 | 18 | right | 64 lb | 9.7 ft | RG ? | 9P28 | ???? | ???? | | \$988 | \$1,294 | \$1,220 |
| 39-7/8 | 24 | 18 | left | 77 lb | 12.6 ft | LG ? | 7P28 | ???? | ???? | | \$1,021 | \$1,312 | \$1,237 |
| 39-7/8 | 24 | 18 | right | 77 lb | 12.6 ft | RG ? | 7P28 | ???? | ???? | | \$1,021 | \$1,312 | \$1,237 |
| 51-3/8 | 18 | 18 | left | 78 lb | 12 ft | LG ? | 1P28 | ???? | ???? | | \$1,195 | \$1,514 | \$1,438 |
| 51-3/8 | 18 | 18 | right | 78 lb | 12 ft | RG ? | 1P28 | ???? | ???? | | \$1,195 | \$1,514 | \$1,438 |
| 51-3/8 | 24 | 18 | left | 89 lb | 16.1 ft | LG ? | 9N28 | ???? | ???? | | \$1,254 | \$1,573 | \$1,497 |
| 51-3/8 | 24 | 18 | right | 89 lb | 16.1 ft | RG ? | 9N28 | ???? | ???? | | \$1,254 | \$1,573 | \$1,497 |
| 65-7/8 | 18 | 18 | left | 93 lb | 15.2 ft | LG ? | 8N28 | ???? | ???? | | \$1,395 | \$1,859 | \$1,751 |
| 65-7/8 | 18 | 18 | right | 93 lb | 15.2 ft | RG ? | 8N28 | ???? | ???? | | \$1,395 | \$1,859 | \$1,751 |
| 65-7/8 | 24 | 18 | left | 112 lb | 20.4 ft | LG ? | 7N28 | ???? | ???? | | \$1,460 | \$1,924 | \$1,816 |
| 65-7/8 | 24 | 18 | right | 112 lb | 20.4 ft | RG ? | 7N28 | ???? | ???? | | \$1,460 | \$1,924 | \$1,816 |
| (2) 18d x 18w adj. metal shelves | | | | 3 lb | 1.5 ft | | ALT21818 | ???? | | | \$237 | \$237 | \$237 |
| (2) 24d x 18w adj. metal shelves | | | | 4 lb | 1.5 ft | | ALT21824 | ???? | | | \$256 | \$256 | \$256 |

Available Fronts | A | ~~B~~ | ~~C~~ | ~~D~~ | ~~E~~ | ~~F~~ | ~~G~~ | ~~H~~ | ~~I~~ | ~~J~~ | ~~K~~ | ~~L~~ | ~~M~~ | ~~N~~ | ~~O~~ | ~~P~~ | Q | S | Y

TRACE 18" Wide Double Locker

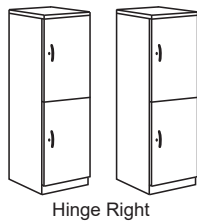

- Double Door lockers do not include shelves. If desired, adjustable shelves may be ordered separately.
- Both doors hinge together, either left or right
- Each locker compartment includes (2) two-pronged coat hooks, one per side
- The two locker doors are keyed randomly in the factory

| H | D | W | Hinge Location | Pkg Wt | Pkg Cube | Part # | Front Style | Part # | Metal Color | Laminate | Metal Door Price | HPL Door Price | TFL Door Price |
|---|----|----|----------------|--------|----------|--------|-------------|--------|-------------|----------|------------------|----------------|----------------|
| 65-7/8 | 18 | 18 | left | 94 lb | 15.2 ft | LG ? | 2PH7 | ???? | ???? | | \$1,458 | \$2,176 | \$2,047 |
| 65-7/8 | 18 | 18 | right | 94 lb | 15.2 ft | RG ? | 2PH7 | ???? | ???? | | \$1,458 | \$2,176 | \$2,047 |
| 65-7/8 | 24 | 18 | left | 115 lb | 20.4 ft | LG ? | 8SH7 | ???? | ???? | | \$1,516 | \$2,234 | \$2,105 |
| 65-7/8 | 24 | 18 | right | 115 lb | 20.4 ft | RG ? | 8SH7 | ???? | ???? | | \$1,516 | \$2,234 | \$2,105 |
| (2) 18d x 18w adj. metal shelves | | | | 3 lb | 1.5 ft | | ALT21818 | ???? | | | \$237 | \$237 | \$237 |
| (2) 24d x 18w adj. metal shelves | | | | 4 lb | 1.5 ft | | ALT21824 | ???? | | | \$256 | \$256 | \$256 |

Available Fronts | A | ~~B~~ | ~~C~~ | ~~D~~ | ~~E~~ | ~~F~~ | ~~G~~ | ~~H~~ | ~~I~~ | ~~J~~ | ~~K~~ | ~~L~~ | ~~M~~ | ~~N~~ | ~~O~~ | ~~P~~ | Q | S | Y

SEE PAGE 2 FOR COLORS, LAMINATES

TRACE Multi-Purpose Locker

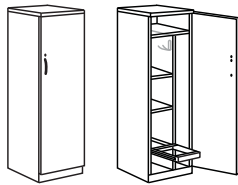

Hinge Right

- Includes a fixed shelf on top, two adjustable shelves, pull-out hanging file rack, and coat storage, all in an 18" 18" footprint
- Coat compartment includes a single two-pronged hook, located on the hinge side of the locker
- Hanging file rack accommodates 8.25 filing inches

| H | D | W | Hinge Location | Pkg Wt | Pkg Cube | Part # | Front Style | Part # | Metal Color | Laminate | Metal Door Price | HPL Door Price | TFL Door Price | | | | | | | | | | | | | | |
|---|----|----|----------------|--------|----------|--------|-------------|----------|-------------|----------|------------------|----------------|----------------|---|---|---|---|---|---|---|---|---|---|---|---|---|---|
| 65-7/8 | 18 | 18 | left | 127 lb | 15.2 ft | LG | ? | 6SS7 | ???? | ???? | \$1,458 | \$1,922 | \$1,814 | | | | | | | | | | | | | | |
| 65-7/8 | 18 | 18 | right | 127 lb | 15.2 ft | RG | ? | 6SS7 | ???? | ???? | \$1,458 | \$1,922 | \$1,814 | | | | | | | | | | | | | | |
| (2) multi-purpose adj. metal shelves | | | | 3 lb | 1 ft | | | ALT22180 | ???? | | \$237 | \$237 | \$237 | | | | | | | | | | | | | | |
| Available Fronts | | | | | | | | | | A | B | C | D | E | F | G | H | I | J | K | L | M | N | P | Q | S | Y |

TRACE Quad Locker



Hinge Left

- Quad lockers do not include shelves. If desired, adjustable shelves may be ordered separately.
- Each locker compartment includes (2) two-pronged coat hooks, one per side
- The four locker doors are keyed randomly in the factory
- The four locker doors hinge together, either left or right

| H | D | W | Hinge Location | Pkg Wt | Pkg Cube | Part # | Front Style | Part # | Metal Color | Laminate | Metal Door Price | HPL Door Price | TFL Door Price | | | | | | | | | | | | | | |
|---|----|----|----------------|--------|----------|--------|-------------|----------|-------------|----------|------------------|----------------|----------------|---|---|---|---|---|---|---|---|---|---|---|---|---|---|
| 65-7/8 | 18 | 24 | left | 142 lb | 20.5 ft | LG | ? | 4NJ7 | ???? | ???? | \$1,983 | \$3,124 | \$2,918 | | | | | | | | | | | | | | |
| 65-7/8 | 18 | 24 | right | 142 lb | 20.5 ft | RG | ? | 4NJ7 | ???? | ???? | \$1,983 | \$3,124 | \$2,918 | | | | | | | | | | | | | | |
| (4) quad locker adj. metal shelves | | | | 11 lb | 1 ft | | | ALT41824 | ???? | | \$270 | \$270 | \$270 | | | | | | | | | | | | | | |
| Available Fronts | | | | | | | | | | A | B | C | D | E | F | G | H | I | J | K | L | M | N | P | Q | S | Y |

CUBBY LOCKERS WITH KEYED LOCKS

SIN 711-3

SEE PAGE 2 FOR COLORS, LAMINATES

Trace Single Wide Cubby Locker

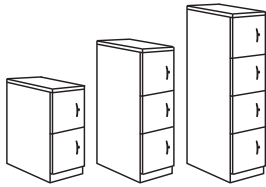

Hinge Left

- Cubby lockers do not include shelves or coat hooks
- The inside clear dimensions: 14.75" height x 10.58" width x 17.15" deep
- Cubby locker doors are keyed randomly in the factory
- All Cubby locker doors hinge together, either left or right

| H | D | W | Doors | Hinge Location | Pkg Wt | Pkg Cube | Part # | Front Style | Part # | Metal Color | Laminate | Metal Door Price | HPL Door Price | TFL Door Price |
|--------|----|----|---------|----------------|--------|----------|--------|-------------|--------|-------------|----------|------------------|----------------|----------------|
| 34-3/4 | 18 | 12 | 2 doors | left | 50 lb | 5.9 ft | LG ? | 6JT7 | ???? | ???? | | \$1,085 | \$1,469 | \$1,400 |
| 34-3/4 | 18 | 12 | 2 doors | right | 50 lb | 5.9 ft | RG ? | 6JT7 | ???? | ???? | | \$1,085 | \$1,469 | \$1,400 |
| 50-3/8 | 18 | 12 | 3 doors | left | 70 lb | 8.4 ft | LG ? | 5HT3 | ???? | ???? | | \$1,280 | \$1,857 | \$1,753 |
| 50-3/8 | 18 | 12 | 3 doors | right | 70 lb | 8.4 ft | RG ? | 5HT3 | ???? | ???? | | \$1,280 | \$1,857 | \$1,753 |
| 65-7/8 | 18 | 12 | 4 doors | left | 89 lb | 11 ft | LG ? | 5JT6 | ???? | ???? | | \$1,566 | \$2,335 | \$2,197 |
| 65-7/8 | 18 | 12 | 4 doors | right | 89 lb | 11 ft | RG ? | 5JT6 | ???? | ???? | | \$1,566 | \$2,335 | \$2,197 |

Available Fronts | A | B | C | D | E | F | G | H | I | J | K | L | M | N | O | P | Q | S | Y

Trace Double Wide Cubby Locker

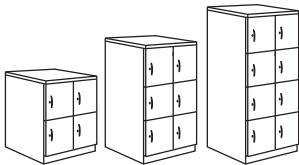

Hinge Right

- Cubby lockers do not include shelves or coat hooks
- The inside clear dimensions: 14.75" height x 10.58" width x 17.15" deep
- Cubby locker doors are keyed randomly in the factory
- All Cubby locker doors hinge together, either left or right

| H | D | W | Doors | Hinge Location | Pkg Wt | Pkg Cube | Part # | Front Style | Part # | Metal Color | Laminate | Metal Door Price | HPL Door Price | TFL Door Price |
|--------|----|----|---------|----------------|--------|----------|--------|-------------|--------|-------------|----------|------------------|----------------|----------------|
| 34-3/4 | 18 | 24 | 4 doors | left | 88 lb | 11 ft | LG ? | 9HN7 | ???? | ???? | | \$1,820 | \$2,589 | \$2,451 |
| 34-3/4 | 18 | 24 | 4 doors | right | 88 lb | 11 ft | RG ? | 9HN7 | ???? | ???? | | \$1,820 | \$2,589 | \$2,451 |
| 50-3/8 | 18 | 24 | 6 doors | left | 119 lb | 15.7 ft | LG ? | 8HT1 | ???? | ???? | | \$2,236 | \$3,389 | \$3,182 |
| 50-3/8 | 18 | 24 | 6 doors | right | 119 lb | 15.7 ft | RG ? | 8HT1 | ???? | ???? | | \$2,236 | \$3,389 | \$3,182 |
| 65-7/8 | 18 | 24 | 8 doors | left | 150 lb | 20.5 ft | LG ? | 7HN6 | ???? | ???? | | \$2,722 | \$4,260 | \$3,983 |
| 65-7/8 | 18 | 24 | 8 doors | right | 150 lb | 20.5 ft | RG ? | 7HN6 | ???? | ???? | | \$2,722 | \$4,260 | \$3,983 |

Available Fronts | A | B | C | D | E | F | G | H | I | J | K | L | M | N | O | P | Q | S | Y

SEE PAGE 2 FOR COLORS, LAMINATES

Mobile Mini Locker



Hinge Right

- Includes one adjustable shelf
- 37mm black casters, two locking and two non-locking, are field-installed
- Includes a counter-weight for stability

| H | D | W | Hinge Location | Pkg Wt | Pkg Cube | Part # | Front Style | Part # | Metal Color | Laminate | Metal Door Price | HPL Door Price | TFL Door Price |
|--------|--------|----|----------------|--------|----------|--------|-------------|--------|-------------|----------|------------------|----------------|----------------|
| 21-3/4 | 18-1/4 | 10 | left | 53 lb | 3.16 ft | LG | ? | 9C28 | ???? | ???? | \$856 | \$886 | \$885 |
| 21-3/4 | 18-1/4 | 10 | right | 53 lb | 3.16 ft | RG | ? | 9C28 | ???? | ???? | \$856 | \$886 | \$885 |

| | | | | | | | | | | | | | | | | | | | |
|------------------|---|---|---|---|---|---|---|---|---|---|---|---|---|---|---|---|---|---|---|
| Available Fronts | A | B | C | D | E | F | G | H | I | J | K | L | M | N | O | P | Q | S | Y |
|------------------|---|---|---|---|---|---|---|---|---|---|---|---|---|---|---|---|---|---|---|

Freestanding Mini Locker



Hinge Left

- Includes one adjustable shelf

| H | D | W | Hinge Location | Pkg Wt | Pkg Cube | Part # | Front Style | Part # | Metal Color | Laminate | Metal Door Price | HPL Door Price | TFL Door Price |
|----|--------|----|----------------|--------|----------|--------|-------------|--------|-------------|----------|------------------|----------------|----------------|
| 20 | 18-1/4 | 10 | left | 33 lb | 3.16 ft | LG | ? | 8D28 | ???? | ???? | \$821 | \$851 | \$850 |
| 20 | 18-1/4 | 10 | right | 33 lb | 3.16 ft | RG | ? | 8D28 | ???? | ???? | \$821 | \$851 | \$850 |

| | | | | | | | | | | | | | | | | | | | |
|------------------|---|---|---|---|---|---|---|---|---|---|---|---|---|---|---|---|---|---|---|
| Available Fronts | A | B | C | D | E | F | G | H | I | J | K | L | M | N | O | P | Q | S | Y |
|------------------|---|---|---|---|---|---|---|---|---|---|---|---|---|---|---|---|---|---|---|

SEE PAGE 2 FOR COLORS, LAMINATES



GO Keyless!

All Great Openings lockers may be ordered to include electronic locks rather than keyed locks. Durable and flexible, electronic locks are easily programmed to either fixed or revolving mode:

Fixed Mode:

Once a code is created, that code remains in effect until the user changes it. To lock and unlock, simply enter the code and then turn the lever.

Revolving Mode:

Also called hoteling or single use mode, the code is cleared after each complete locking cycle. To lock: enter a code and then turn the lever. To unlock: enter the same code and turn the lever. At this point the lock clears the code and is awaiting new input.

Electronic Lock Features

- Once a code is entered, the lock is activated by turning the lever to the locked or unlocked position
- Runs on 2 AAA batteries (included)
- Operates using a 4-to-8 digit code
- A supervisor code is included
- May be programmed by supervisor as Fixed or Revolving Code
- Programmable reset features
- Easy to clean membrane keypad
- 75,000 plus cycles; extended battery life reduces replacement and labor/maintenance costs.

Warranty

- Great Openings electronic locks are warranted for a period of one year from date of delivery.

Door options when ordering electronics locks:



A: Full Pull with E-Lock



E: Integrated Lock Pull

SEE PAGE 2 FOR COLORS, LAMINATES

TRACE 12" Wide Single Locker Electronic Lock

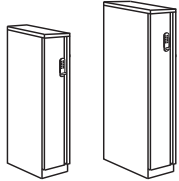

51-3/8" H 65-7/8" H
18" D 24" D
Hinge Left Hinge Left

- 51-3/8" and 65-7/8" high lockers include one adjustable shelf on top, with up to 12" clear height above the shelf.
- 39-7/8" high lockers do not include any shelves.
- All single door lockers include two clusters of shelf clip holes in the side panels, to accommodate additional shelves that are sold separately. One cluster near the top of the locker allows for 3" adjustability, with up to 12" clear height above the shelf. A second cluster near the bottom of the locker allows for 3" adjustability, with up to 8" clear height below the shelf.
- The 18" deep lockers include (2) two-pronged coat hooks, one on each side. The 24" deep lockers include (1) side-to-side coat rod.

| H | D | W | Hinge Location | Pkg Wt | Pkg Cube | Part # | Front Style | Part # | Metal Color | Laminate | Metal Door Price | HPL Door Price | TFL Door Price |
|---|----|----|----------------|--------|----------|--------|-------------|--------|-------------|----------|------------------|----------------|----------------|
| 39-7/8 | 18 | 12 | left | 55 lb | 7.8 ft | LE ? | 3P28 | ???? | ???? | | \$1,312 | \$1,523 | \$1,512 |
| 39-7/8 | 18 | 12 | right | 55 lb | 7.8 ft | RE ? | 3P28 | ???? | ???? | | \$1,312 | \$1,523 | \$1,512 |
| 39-7/8 | 24 | 12 | left | 66 lb | 8.0 ft | LE ? | 8P28 | ???? | ???? | | \$1,328 | \$1,555 | \$1,544 |
| 39-7/8 | 24 | 12 | right | 66 lb | 8.0 ft | RE ? | 8P28 | ???? | ???? | | \$1,328 | \$1,555 | \$1,544 |
| 51-3/8 | 18 | 12 | left | 69 lb | 8.24 ft | LE ? | 7M28 | ???? | ???? | | \$1,519 | \$1,740 | \$1,679 |
| 51-3/8 | 18 | 12 | right | 69 lb | 8.24 ft | RE ? | 7M28 | ???? | ???? | | \$1,519 | \$1,740 | \$1,679 |
| 51-3/8 | 24 | 12 | left | 83 lb | 10.5 ft | LE ? | 6M28 | ???? | ???? | | \$1,574 | \$1,795 | \$1,734 |
| 51-3/8 | 24 | 12 | right | 83 lb | 10.5 ft | RE ? | 6M28 | ???? | ???? | | \$1,574 | \$1,795 | \$1,734 |
| 65-7/8 | 18 | 12 | left | 82 lb | 10.5 ft | LE ? | 1N28 | ???? | ???? | | \$1,549 | \$1,889 | \$1,803 |
| 65-7/8 | 18 | 12 | right | 82 lb | 10.5 ft | RE ? | 1N28 | ???? | ???? | | \$1,549 | \$1,889 | \$1,803 |
| 65-7/8 | 24 | 12 | left | 100 lb | 13.28 ft | LE ? | 9M28 | ???? | ???? | | \$1,604 | \$1,944 | \$1,858 |
| 65-7/8 | 24 | 12 | right | 100 lb | 13.28 ft | RE ? | 9M28 | ???? | ???? | | \$1,604 | \$1,944 | \$1,858 |
| (2) 18d x 12w adj. metal shelves | | | | 2.5 lb | 1 ft | | ALT21218 | ???? | | | \$218 | \$218 | \$218 |
| (2) 24d x 12w adj. metal shelves | | | | 4 lb | 1.5 ft | | ALT21224 | ???? | | | \$235 | \$235 | \$235 |

Available Fronts | A ~~B~~ ~~C~~ E ~~F~~ ~~G~~ ~~H~~ ~~I~~ ~~J~~ ~~K~~ ~~L~~ ~~M~~ ~~N~~ ~~O~~ ~~P~~ ~~Q~~ ~~R~~ ~~S~~ ~~X~~

TRACE 12" Wide Double Locker Electronic Lock

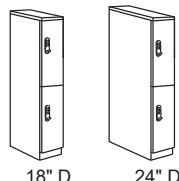

18" D 24" D
Hinge Right Hinge Right

- Double Door lockers do not include shelves. If desired, adjustable shelves may be ordered separately.
- Both doors hinge together, either left or right
- Each locker compartment includes (2) two-pronged coat hooks, one per side
- The two locker doors are keyed randomly in the factory

| H | D | W | Hinge Location | Pkg Wt | Pkg Cube | Part # | Front Style | Part # | Metal Color | Laminate | Metal Door Price | HPL Door Price | TFL Door Price |
|---|----|----|----------------|--------|----------|--------|-------------|--------|-------------|----------|------------------|----------------|----------------|
| 65-7/8 | 18 | 12 | left | 83 lb | 11 ft | LE ? | 3NH7 | ???? | ???? | | \$2,066 | \$2,636 | \$2,534 |
| 65-7/8 | 18 | 12 | right | 83 lb | 11 ft | RE ? | 3NH7 | ???? | ???? | | \$2,066 | \$2,636 | \$2,534 |
| 65-7/8 | 24 | 12 | left | 101 lb | 14.3 ft | LE ? | 2NH7 | ???? | ???? | | \$2,121 | \$2,691 | \$2,589 |
| 65-7/8 | 24 | 12 | right | 101 lb | 14.3 ft | RE ? | 2NH7 | ???? | ???? | | \$2,121 | \$2,691 | \$2,589 |
| (2) 18d x 12w adj. metal shelves | | | | 2.5 lb | 1 ft | | ALT21218 | ???? | | | \$218 | \$218 | \$218 |
| (2) 24d x 12w adj. metal shelves | | | | 2.5 lb | 1 ft | | ALT21224 | ???? | | | \$235 | \$235 | \$235 |

Available Fronts | A ~~B~~ ~~C~~ E ~~F~~ ~~G~~ ~~H~~ ~~I~~ ~~J~~ ~~K~~ ~~L~~ ~~M~~ ~~N~~ ~~O~~ ~~P~~ ~~Q~~ ~~R~~ ~~S~~ ~~X~~

18" LOCKERS WITH ELECTRONIC LOCKS

SIN 711-3

SEE PAGE 2 FOR COLORS, LAMINATES

TRACE 18" Wide Locker Electronic Lock

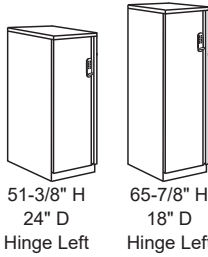

- 51-3/8" and 65-7/8" high lockers include one adjustable shelf on top, with up to 12" clear height above the shelf.
- 39-7/8" high lockers do not include any shelves.
- All single door lockers include two clusters of shelf clip holes in the side panels, to accommodate additional shelves that are sold separately. One cluster near the top of the locker allows for 3" adjustability, with up to 12" clear height above the shelf. A second cluster near the bottom of the locker allows for 3" adjustability, with up to 8" clear height below the shelf.
- The 18" deep lockers include (2) two-pronged coat hooks, one on each side. The 24" deep lockers include (1) side-to-side coat rod.

TRACE 18" Wide Double Locker Electronic Lock

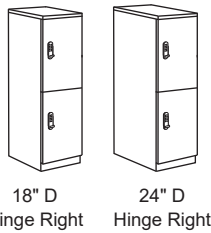

- Double Door lockers do not include shelves. If desired, adjustable shelves may be ordered separately.
- Both doors hinge together, either left or right
- Each locker compartment includes (2) two-pronged coat hooks, one per side
- The two locker doors are keyed randomly in the factory

| H | D | W | Hinge Location | Pkg Wt | Pkg Cube | Part # | Front Style | Part # | Metal Color | Laminate | Metal Door Price | HPL Door Price | TFL Door Price |
|---|----|----|----------------|--------|----------|--------|-------------|--------|-------------|----------|------------------|----------------|----------------|
| 39-7/8 | 18 | 18 | left | 64 lb | 9.7 ft | LE ? | 9P28 | ???? | ???? | | \$1,334 | \$1,629 | \$1,669 |
| 39-7/8 | 18 | 18 | right | 64 lb | 9.7 ft | RE ? | 9P28 | ???? | ???? | | \$1,334 | \$1,629 | \$1,669 |
| 39-7/8 | 24 | 18 | left | 77 lb | 12.6 ft | LE ? | 7P28 | ???? | ???? | | \$1,366 | \$1,646 | \$1,686 |
| 39-7/8 | 24 | 18 | right | 77 lb | 12.6 ft | RE ? | 7P28 | ???? | ???? | | \$1,366 | \$1,646 | \$1,686 |
| 51-3/8 | 18 | 18 | left | 78 lb | 12 ft | LE ? | 1P28 | ???? | ???? | | \$1,529 | \$1,848 | \$1,772 |
| 51-3/8 | 18 | 18 | right | 78 lb | 12 ft | RE ? | 1P28 | ???? | ???? | | \$1,529 | \$1,848 | \$1,772 |
| 51-3/8 | 24 | 18 | left | 89 lb | 16.1 ft | LE ? | 9N28 | ???? | ???? | | \$1,588 | \$1,907 | \$1,831 |
| 51-3/8 | 24 | 18 | right | 89 lb | 16.1 ft | RE ? | 9N28 | ???? | ???? | | \$1,588 | \$1,907 | \$1,831 |
| 65-7/8 | 18 | 18 | left | 93 lb | 15.2 ft | LE ? | 8N28 | ???? | ???? | | \$1,729 | \$2,193 | \$2,085 |
| 65-7/8 | 18 | 18 | right | 93 lb | 15.2 ft | RE ? | 8N28 | ???? | ???? | | \$1,729 | \$2,193 | \$2,085 |
| 65-7/8 | 24 | 18 | left | 105 lb | 20.4 ft | LE ? | 7N28 | ???? | ???? | | \$1,794 | \$2,258 | \$2,150 |
| 65-7/8 | 24 | 18 | right | 105 lb | 20.4 ft | RE ? | 7N28 | ???? | ???? | | \$1,794 | \$2,258 | \$2,150 |
| (2) 18d x 18w adj. metal shelves | | | | 3 lb | 1 ft | | ALT21818 | ???? | | | \$237 | \$237 | \$237 |
| (2) 24d x 18w adj. metal shelves | | | | 4 lb | 1.5 ft | | ALT21824 | ???? | | | \$256 | \$256 | \$256 |

Available Fronts | A ~~B~~ ~~C~~ E ~~F~~ ~~G~~ ~~H~~ ~~I~~ ~~J~~ ~~K~~ ~~L~~ ~~M~~ ~~N~~ ~~O~~ ~~P~~ ~~Q~~ ~~R~~ ~~S~~ ~~T~~ ~~U~~ ~~V~~ ~~W~~ ~~X~~ ~~Y~~ ~~Z~~

| H | D | W | Hinge Location | Pkg Wt | Pkg Cube | Part # | Front Style | Part # | Metal Color | Laminate | Metal Door Price | HPL Door Price | TFL Door Price |
|--|----|----|----------------|--------|----------|--------|-------------|--------|-------------|----------|------------------|----------------|----------------|
| 65-7/8 | 18 | 18 | left | 94 lb | 15.2 ft | LE ? | 2PH7 | ???? | ???? | | \$2,126 | \$2,844 | \$2,715 |
| 65-7/8 | 18 | 18 | right | 94 lb | 15.2 ft | RE ? | 2PH7 | ???? | ???? | | \$2,126 | \$2,844 | \$2,715 |
| 65-7/8 | 24 | 18 | left | 115 lb | 20.4 ft | LE ? | 8SH7 | ???? | ???? | | \$2,184 | \$2,902 | \$2,773 |
| 65-7/8 | 24 | 18 | right | 115 lb | 20.4 ft | RE ? | 8SH7 | ???? | ???? | | \$2,184 | \$2,902 | \$2,773 |
| (2) 18 d x 18w adj. metal shelves | | | | 3 lb | 1.5 ft | | ALT21818 | ???? | | | \$237 | \$237 | \$237 |
| (2) 24 d x 18w adj. metal shelves | | | | 3 lb | 1.5 ft | | ALT21824 | ???? | | | \$256 | \$256 | \$256 |

Available Fronts | A ~~B~~ ~~C~~ E ~~F~~ ~~G~~ ~~H~~ ~~I~~ ~~J~~ ~~K~~ ~~L~~ ~~M~~ ~~N~~ ~~O~~ ~~P~~ ~~Q~~ ~~R~~ ~~S~~ ~~T~~ ~~U~~ ~~V~~ ~~W~~ ~~X~~ ~~Y~~ ~~Z~~

SEE PAGE 2 FOR COLORS, LAMINATES

TRACE Multi-Purpose Locker Electronic Lock

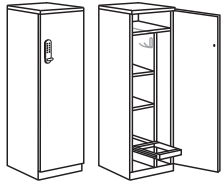

Hinge Right

- Includes a fixed shelf on top, two adjustable shelves, pull-out hanging file rack, and coat storage, all in an 18" 18" footprint
- Coat compartment includes a single two-pronged hook, located on the hinge side of the locker
- Hanging file rack accommodates 8.25 filing inches

| H | D | W | Hinge Location | Pkg Wt | Pkg Cube | Part # | Front Style | Part # | Metal Color | Laminate | Metal Door Price | HPL Door Price | TFL Door Price |
|--|----|----|----------------|--------|----------|--------|-------------|----------|-------------|----------|------------------|----------------|----------------|
| 65-7/8 | 18 | 18 | left | 127 lb | 15.2 ft | LE ? | ? | 6SS7 | ???? | ???? | \$1,793 | \$2,257 | \$2,149 |
| 65-7/8 | 18 | 18 | right | 127 lb | 15.2 ft | RE ? | ? | 6SS7 | ???? | ???? | \$1,793 | \$2,257 | \$2,149 |
| (2) multi-purpose locker adj. metal shelves | | | | 3 lb | 1 ft | | | ALT22180 | ???? | | \$237 | \$237 | \$237 |

Available Fronts | A ~~B~~ ~~C~~ ~~D~~ E ~~F~~ ~~G~~ ~~H~~ ~~I~~ ~~J~~ ~~K~~ ~~L~~ ~~M~~ ~~N~~ ~~O~~ ~~P~~ ~~Q~~ ~~R~~ ~~S~~ ~~T~~

TRACE Quad Locker Electronic Lock



Hinge Left

- Quad lockers do not include shelves. If desired, adjustable shelves may be ordered separately.
- Each locker compartment includes (2) two-pronged coat hooks, one per side
- The four locker doors are keyed randomly in the factory
- The four locker doors hinge together, either left or right

| H | D | W | Hinge Location | Pkg Wt | Pkg Cube | Part # | Front Style | Part # | Metal Color | Laminate | Metal Door Price | HPL Door Price | TFL Door Price |
|---|----|----|----------------|--------|----------|--------|-------------|----------|-------------|----------|------------------|----------------|----------------|
| 65-7/8 | 18 | 24 | left | 142 lb | 20.5 ft | LE ? | ? | 4NJ7 | ???? | ???? | \$3,319 | \$4,460 | \$4,254 |
| 65-7/8 | 18 | 24 | right | 142 lb | 20.5 ft | RE ? | ? | 4NJ7 | ???? | ???? | \$3,319 | \$4,460 | \$4,254 |
| 4 quad locker adj. metal shelves | | | | 11 lb | 1 ft | | | ALT41824 | ???? | | \$270 | \$270 | \$270 |

Available Fronts | A ~~B~~ ~~C~~ ~~D~~ E ~~F~~ ~~G~~ ~~H~~ ~~I~~ ~~J~~ ~~K~~ ~~L~~ ~~M~~ ~~N~~ ~~O~~ ~~P~~ ~~Q~~ ~~R~~ ~~S~~ ~~T~~

CUBBY LOCKERS WITH ELECTRONIC LOCKS

SIN 711-3

SEE PAGE 2 FOR COLORS, LAMINATES

Trace Single Wide Cubby Locker Electronic Lock

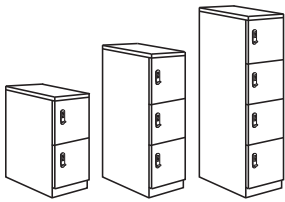

Hinge Right

- Cubby lockers do not include shelves or coat hooks
- The inside clear dimensions: 14.75" height x 10.58" width x 17.15" deep
- Cubby locker doors are keyed randomly in the factory
- All Cubby locker doors hinge together, either left or right

| H | D | W | Doors | Hinge Location | Pkg Wt | Pkg Cube | Part # | Front Style | Part # | Metal Color | Laminate | Metal Door Price | HPL Door Price | TFL Door Price |
|--------|----|----|---------|----------------|--------|----------|--------|-------------|--------|-------------|----------|------------------|----------------|----------------|
| 34-3/4 | 18 | 12 | 2 doors | left | 50 lb | 5.9 ft | LE ? | 6JT7 | ???? | ???? | | \$1,712 | \$2,096 | \$2,027 |
| 34-3/4 | 18 | 12 | 2 doors | right | 50 lb | 5.9 ft | RE ? | 6JT7 | ???? | ???? | | \$1,712 | \$2,096 | \$2,027 |
| 50-3/8 | 18 | 12 | 3 doors | left | 70 lb | 8.4 ft | LE ? | 5HT3 | ???? | ???? | | \$2,219 | \$2,796 | \$2,692 |
| 50-3/8 | 18 | 12 | 3 doors | right | 70 lb | 8.4 ft | RE ? | 5HT3 | ???? | ???? | | \$2,219 | \$2,796 | \$2,692 |
| 65-7/8 | 18 | 12 | 4 doors | left | 89 lb | 11 ft | LE ? | 5JT6 | ???? | ???? | | \$2,819 | \$3,588 | \$3,450 |
| 65-7/8 | 18 | 12 | 4 doors | right | 89 lb | 11 ft | RE ? | 5JT6 | ???? | ???? | | \$2,819 | \$3,588 | \$3,450 |

Available Fronts | A E

Trace Double Wide Cubby Locker Electronic Lock

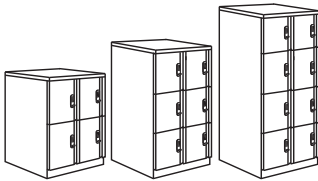

Hinge Left

- Cubby lockers do not include shelves or coat hooks
- The inside clear dimensions: 14.75" height x 10.58" width x 17.15" deep
- Cubby locker doors are keyed randomly in the factory
- All Cubby locker doors hinge together, either left or right

| H | D | W | Doors | Hinge Location | Pkg Wt | Pkg Cube | Part # | Front Style | Part # | Metal Color | Laminate | Metal Door Price | HPL Door Price | TFL Door Price |
|--------|----|----|---------|----------------|--------|----------|--------|-------------|--------|-------------|----------|------------------|----------------|----------------|
| 34-3/4 | 18 | 24 | 4 doors | left | 88 lb | 11 ft | LE ? | 9HN7 | ???? | ???? | | \$3,494 | \$4,263 | \$4,125 |
| 34-3/4 | 18 | 24 | 4 doors | right | 88 lb | 11 ft | RE ? | 9HN7 | ???? | ???? | | \$3,494 | \$4,263 | \$4,125 |
| 50-3/8 | 18 | 24 | 6 doors | left | 119 lb | 15.7 ft | LE ? | 8HT1 | ???? | ???? | | \$4,741 | \$5,894 | \$5,687 |
| 50-3/8 | 18 | 24 | 6 doors | right | 119 lb | 15.7 ft | RE ? | 8HT1 | ???? | ???? | | \$4,741 | \$5,894 | \$5,687 |
| 65-7/8 | 18 | 24 | 8 doors | left | 150 lb | 20.5 ft | LE ? | 7HN6 | ???? | ???? | | \$6,064 | \$7,602 | \$7,325 |
| 65-7/8 | 18 | 24 | 8 doors | right | 150 lb | 20.5 ft | RE ? | 7HN6 | ???? | ???? | | \$6,064 | \$7,602 | \$7,325 |

Available Fronts | A E

SEE PAGE 2 FOR COLORS, LAMINATES

**Mobile Mini Locker
Electronic Lock**



Hinge Right

- Includes one adjustable shelf
- 37mm black casters, two locking and two non-locking, are field-installed
- Includes a counter-weight for stability

| H | D | W | Hinge Location | Pkg Wt | Pkg Cube | Part # | Front Style | Part # | Metal Color | Laminate | Metal Door Price | HPL Door Price | TFL Door Price |
|--------|--------|----|----------------|--------|----------|--------|-------------|--------|-------------|----------|------------------|----------------|----------------|
| 21-3/4 | 18-1/4 | 10 | left | 53 lb | 3.16 ft | LE | ? | 9C28 | ???? | ???? | \$1,200 | \$1,230 | \$1,229 |
| 21-3/4 | 18-1/4 | 10 | right | 53 lb | 3.16 ft | RE | ? | 9C28 | ???? | ???? | \$1,200 | \$1,230 | \$1,229 |

| | | | | | | | | | | | | | | | | | | | | | | | | | | |
|------------------|---|--------------|--------------|--------------|---|--------------|--------------|--------------|--------------|--------------|--------------|--------------|--------------|--------------|--------------|--------------|--------------|--------------|--------------|--------------|--------------|--------------|--------------|--------------|--------------|--------------|
| Available Fronts | A | B | C | D | E | F | G | H | I | J | K | L | M | N | O | P | Q | R | S | T | U | V | W | X | Y | Z |
|------------------|---|--------------|--------------|--------------|---|--------------|--------------|--------------|--------------|--------------|--------------|--------------|--------------|--------------|--------------|--------------|--------------|--------------|--------------|--------------|--------------|--------------|--------------|--------------|--------------|--------------|

**Freestanding Mini Locker
Electronic Lock**



Hinge Right

- Includes one adjustable shelf

| H | D | W | Hinge Location | Pkg Wt | Pkg Cube | Part # | Front Style | Part # | Metal Color | Laminate | Metal Door Price | HPL Door Price | TFL Door Price |
|----|--------|----|----------------|--------|----------|--------|-------------|--------|-------------|----------|------------------|----------------|----------------|
| 20 | 18-1/4 | 10 | left | 33 lb | 3.16 ft | LE | ? | 8D28 | ???? | ???? | \$1,165 | \$1,195 | \$1,194 |
| 20 | 18-1/4 | 10 | right | 33 lb | 3.16 ft | RE | ? | 8D28 | ???? | ???? | \$1,165 | \$1,195 | \$1,194 |

| | | | | | | | | | | | | | | | | | | | | | | | | | | |
|------------------|---|--------------|--------------|--------------|---|--------------|--------------|--------------|--------------|--------------|--------------|--------------|--------------|--------------|--------------|--------------|--------------|--------------|--------------|--------------|--------------|--------------|--------------|--------------|--------------|--------------|
| Available Fronts | A | B | C | D | E | F | G | H | I | J | K | L | M | N | O | P | Q | R | S | T | U | V | W | X | Y | Z |
|------------------|---|--------------|--------------|--------------|---|--------------|--------------|--------------|--------------|--------------|--------------|--------------|--------------|--------------|--------------|--------------|--------------|--------------|--------------|--------------|--------------|--------------|--------------|--------------|--------------|--------------|

SEE PAGE 2 FOR COLORS, LAMINATES

Common Laminate Tops for TRACE Lockers



| Laminate Top for Side-by-Side Lockers | W | D | Pkg Wt | Pkg Cube | Part # | Price |
|---------------------------------------|--------|--------|--------|----------|---------|-------|
| (4) 12" wide x 18" deep lockers | 48-1/4 | 18-1/4 | 38 lb | .7 ft | LK 1848 | \$410 |
| (3) 18" wide x 18" deep lockers | 54-1/4 | 18-1/4 | 42 lb | .8 ft | LK 1854 | \$477 |
| (5) 12" wide x 18" deep lockers | 60-1/4 | 18-1/4 | 46 lb | .9 ft | LK 1860 | \$483 |



| Laminate Top for Side-by-Side Double Wide Cubby Lockers | W | D | Pkg Wt | Pkg Cube | Part # | Price |
|---|--------|--------|--------|----------|---------|-------|
| (2) 24" wide x 18" deep lockers | 48-1/4 | 18-1/4 | 41 lb | .8 ft | LK 1848 | \$410 |
| (3) 24" wide x 18" deep lockers | 72-1/4 | 18-1/4 | 64 lb | 1.3 ft | LK 1872 | \$654 |
| (4) 24" wide x 18" deep lockers | 96-1/4 | 18-1/4 | 95 lb | 1.6 ft | LK 1896 | \$767 |

- Laminate tops ordered separately for field installation
- Specify any standard GO laminate or special ordered laminate
- Top sizes allow for 1/8" overhang on all sides
- Common laminate tops will sit on top of locker's metal tops

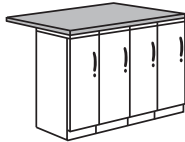

| Laminate Top for Bar-Height Island with Lockers | W | D | Pkg Wt | Pkg Cube | Part # | Price |
|---|--------|--------|--------|----------|---------|-------|
| (4) 12" wide x 18" deep lockers (includes 12" overhang in back) | 48-1/4 | 30-1/4 | 51 lb | 1.0 ft | LK 3048 | \$525 |
| (3) 18" wide x 18" deep lockers (includes 12" overhang in back) | 54-1/4 | 30-1/4 | 58 lb | 1.2 ft | LK 3054 | \$611 |
| (5) 12" wide x 18" deep lockers (includes 12" overhang in back) | 60-1/4 | 30-1/4 | 63 lb | 1.4 ft | LK 3060 | \$627 |



39-7/8" h lockers with 12" overhang and Sly chair shown. Sides and front overhang 1/8"

TRACE Locker Ganging Kit



- Ganging kit is used to snug two lockers together so that between-locker seams stay tight
- Ganging kit includes drill point screws, and instructions

| Description | Pkg Wt | Pkg Cube | Part # | Price |
|----------------------------------|--------|----------|-----------|-------|
| Kit to gang two lockers together | 1 lb | .2 ft | LCK 00025 | \$45 |

Locker Door Number Plates



- Laser etched with any combination of numbers needed to permanently identify individual locker doors
- .024 stainless steel, 1" h x 2" w
- Includes a peel-and-stick adhesive (3M #468MP 5 mil PSA) that provides a permanent attachment to metal, laminate, and TFL doors
- Shipped separately from your locker order. Once lockers are set in place, the number plates may then be installed in the desired order.
- Please specify the quantity and number pattern needed
- If desired, number plates may also be ordered direct from our supplier. Call us for their contact information

| Description | Part # | Order Qty | Price per unit |
|------------------------------|---------|-----------|----------------|
| Stainless steel number plate | DOJ0014 | 25-49 | \$52 |
| | | 50-99 | \$27 |
| | | 100-199 | \$15 |
| | | 200-299 | \$12 |
| | | 300+ | \$10 |

\$75 set-up fee must be applied to each order
Small Order Freight Charge does not apply

To calculate number plate price:

1. Choose the price per number plate (in table above) based on the quantity needed.
2. Multiply # of number plates by price per unit
3. Add \$75 net set-up fee for each order
4. Specify the range of numbers to be printed on the number plates
5. Include the ship-to address on your PO for your number plates, as they will be shipped separately from your lockers

Sample price calculation for 80 number plates:

| | |
|-------------------------------|--------------|
| 80 number plates x \$27 List: | \$2,160 list |
| Apply 70% discount: | \$648 net |
| Add \$75 net set-up fee: | \$75 net |
| Total net price: | \$723 net |

SEE PAGE 2 FOR COLORS, LAMINATES, FABRICS

TRACE Double Door Storage Cabinet



2-high, 1 shelf
28-3/8"



3-high, 2 shelf
39-7/8"

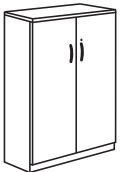

4-high, 3 shelf
51-3/8"

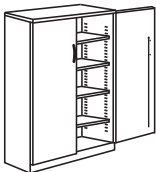

5-high, 4 shelf
65-7/8"

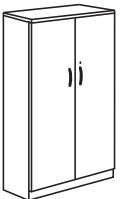

6-high, 5 shelf
77-3/8"

- Horizontal lines and full-width fronts are consistent with all other TRACE products
- UM Series lock, randomly-assigned (#226-425)
- Side and back panels, and doors, are 20-22 gauge
- Inner channels, shelves, and top are 18 gauge
- Concealed hinges allow for 110 degree opening
- Each shelf is 3/4" tall
- Four leveling glides with 1-1/4" adjustment
- Shelves adjustable in 1-1/2" increments
- Inside depth: 17.30"
- Inside width: 26.75" in 30"w unit
32.75" in 36"w unit
38.75" in 42"w unit (gain 1-3/4" once past the hinges)
- Inside heights: 72.47" in 77-3/8"h unit
60.97" in 65-7/8"h unit
46.50" in 51-3/8"h unit
35.00" in 39-7/8"h unit
23.50" in 28-3/8"h unit

Shelf load capacities:
30" shelf: 140 lbs
36" shelf: 140 lbs
42" shelf: 140 lbs

Note: each shelf is 3/4" tall.

Cabinet top weight capacity
30" cabinet: 140 lbs
36" cabinet: 168 lbs
42" cabinet: 197 lbs

For laminate tops, see the TRACE lateral file section

| H | D | W | Description | Pkg Wt | Pkg Cube | Part # | Door Style | Part # | Metal Color | Price |
|--------|--------|----|--|--------|----------|--------|------------|--------|-------------|---------|
| 28-3/8 | 18-1/4 | 30 | | 66 lb | 12.7 ft | CG ? | 01F2 | ? | ? | \$901 |
| 28-3/8 | 18-1/4 | 36 | 2-high double door 1 adjustable shelf | 78 lb | 15.5 ft | CG ? | 02F3 | ? | ? | \$981 |
| 28-3/8 | 18-1/4 | 42 | | 90 lb | 17.3 ft | CG ? | 03F4 | ? | ? | \$1,082 |
| 39-7/8 | 18-1/4 | 30 | | 88 lb | 17.4 ft | CG ? | 04F2 | ? | ? | \$1,098 |
| 39-7/8 | 18-1/4 | 36 | 3-high double door 2 adjustable shelves | 100 lb | 20.6 ft | CG ? | 05F3 | ? | ? | \$1,225 |
| 39-7/8 | 18-1/4 | 42 | | 110 lb | 23.7 ft | CG ? | 06F4 | ? | ? | \$1,306 |
| 51-3/8 | 18-1/4 | 30 | | 113 lb | 22.1 ft | CG ? | 07F2 | ? | ? | \$1,348 |
| 51-3/8 | 18-1/4 | 36 | 4-high double door 3 adjustable shelves | 125 lb | 26.1 ft | CG ? | 08F3 | ? | ? | \$1,466 |
| 51-3/8 | 18-1/4 | 42 | | 137 lb | 30.9 ft | CG ? | 09F4 | ? | ? | \$1,572 |
| 65-7/8 | 18-1/4 | 30 | | 138 lb | 28.0 ft | CG ? | 10F2 | ? | ? | \$1,625 |
| 65-7/8 | 18-1/4 | 36 | 5-high double door 4 adjustable shelves | 150 lb | 33.1 ft | CG ? | 11F3 | ? | ? | \$1,710 |
| 65-7/8 | 18-1/4 | 42 | | 162 lb | 38.1 ft | CG ? | 12F4 | ? | ? | \$1,844 |
| 65-7/8 | 18-1/4 | 36 | 5h x 36w w/coat rod no shelves | 130 lb | 33.0 ft | CG ? | 11F5 | ? | ? | \$1,561 |
| 65-7/8 | 18-1/4 | 36 | 5h x 36w w/shelf top/coat rod below | 130 lb | 33.0 ft | CG ? | 11F6 | ? | ? | \$1,625 |
| 77-3/8 | 18-1/4 | 30 | | 168 lb | 32.6 ft | CG ? | 45F2 | ? | ? | \$1,861 |
| 77-3/8 | 18-1/4 | 36 | 6-high double door 5 adjustable shelves | 180 lb | 38.6 ft | CG ? | 46F3 | ? | ? | \$1,946 |
| 77-3/8 | 18-1/4 | 42 | | 192 lb | 44.5 ft | CG ? | 47F4 | ? | ? | \$2,052 |
| 77-3/8 | 18-1/4 | 36 | 6h x 36w w/ shelf top/coat rod below | 146 lb | 38.6 ft | CG ? | 46F7 | ? | ? | \$1,861 |
| | | | additional 30" shelf | 8 lb | 1.5 ft | | | DBS30 | ? | \$90 |
| | | | additional 36" shelf | 10 lb | 1.5 ft | | | DBS36 | ? | \$90 |
| | | | additional 42" shelf | 12 lb | 1.5 ft | | | DBS42 | ? | \$90 |

Available Fronts | A | B | C | D | E | F | G | H | I | J | K | L | M | N | O | P | Q | S | Y

TRACE Full Depth Double Door Cabinet

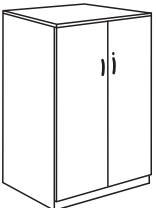

5-high, 4 shelf
65-7/8"

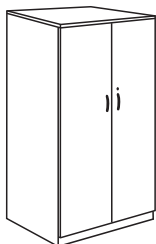

6-high, 5 shelf
77-3/8"

- Side-to-side coat rod
- 1-5/8" leveling glides

| H | D | W | Description | Pkg Wt | Pkg Cube | Part # | Door Style | Part # | Metal Color | Price |
|--------|--------|----|--|--------|----------|--------|------------|---------|-------------|---------|
| 65-7/8 | 23-1/2 | 36 | 5h double door w/ shelf & coat rod | 135 lb | 38 ft | CG ? | U777 | ???? | ? | \$1,889 |
| 65-7/8 | 23-1/2 | 36 | 5h double door 4 adjustable shelves | 165 lb | 38 ft | CG ? | U7F3 | ???? | ? | \$1,987 |
| 77-3/8 | 23-1/2 | 36 | 6h double door w/ shelf & coat rod | 155 lb | 43 ft | CG ? | V877 | ???? | ? | \$2,074 |
| 77-3/8 | 23-1/2 | 36 | 6h double door 5 adjustable shelves | 195 lb | 43 ft | CG ? | V8F3 | ???? | ? | \$2,182 |
| | | | additional shelves and clips | | | | | COL 036 | | \$94 |

Available Fronts | A | B | C | D | E | F | G | H | I | J | K | L | M | N | O | P | Q | S | Y

BOOKCASES

SEE PAGE 2 FOR COLORS, LAMINATES, FABRICS

TRACE Bookcase

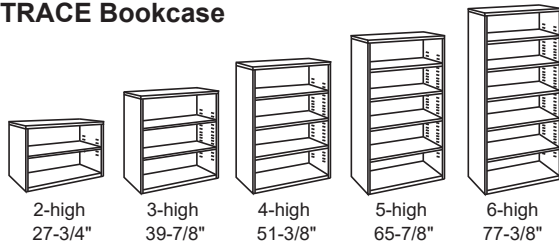

- Front vertical edge is square
- All welded steel frame construction
- Double wall construction on side panels
- Bottom channels, bookcase top and shelves are all 18 gauge, back panel, side channels and side panels are 22 gauge
- Four leveling glides with 5/8" adjustment
- Shelves adjustable in 1/2" increments
- Outer side panels are flush with sides of bookcase top, so no gap between bookcases when installed side-by-side
- Top is mechanically fastened, so may be replaced with laminate top
- To ensure stability, do not install a 4, 5, or 6-high single bookcase in the center of a room. Bookcases should be installed back-to-back or against a wall
- Shelf capacity all widths: 140 lbs
- 2-high bookcases will accommodate binder-height storage on both shelves. For all other bookcases, binder-height storage is available on all but one shelf

| Inside depth: | Inside widths: | Inside heights: | Adjustable shelf: |
|---------------|--------------------|------------------|-------------------|
| 13.06" | 27.69" in 30" case | 25.19" in 2-high | 1" high |
| | 33.69" in 36" case | 37.31" in 3-high | |
| | 39.69" in 42" case | 48.81" in 4-high | |
| | | 63.31" in 5-high | |
| | | 74.81" in 6-high | |

TRACE Bookcase Laminate Top

- Factory installed 1-1/4" laminate top replaces the standard metal top
- Finish height of bookcase will be 5/8" taller than the height of a standard bookcase with metal top
- Laminate top will overhang the metal bookcase sides by 1/8", and it will be flush at front and back
- Specify the laminate and edge band as a suffix to the bookcase part number
- Add the price shown to the list price of the bookcase

Mobile Bookcase

- Black 37mm plastic casters
- Casters: 2 locking, 2 non-locking
- Satin nickel loop pull on each side
- Bookcase itself is 30" wide
- With loop pulls, total width is 32-1/2"
- Inside clear height: 24" with 1/2" shelf
- Inside clear depth: 15", width: 27-7/8"
- Shelf is adjustable in 1/2" increments
- As with all GO bookcases, the mobile bookcase does include a back panel



Magnetic Shelf Divider

- Black divider is 7-1/2" tall, 8" wide
- 4" wide base includes 8" x 3" magnet
- Sold in packages of three dividers

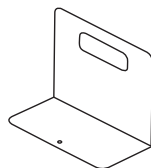

| H | D | W | Shelf Options | Pkg Wt | Pkg Cube | Part # | Metal Color | Price | |
|--------------------|---------|----|---|----------------------|----------|----------|-------------|---------|------|
| 27-3/4 | 13-7/16 | 30 | 2-high bookcase 1 adjustable shelf | 55 lb | 10.0 ft | GBS 3028 | ? | \$680 | |
| 27-3/4 | 13-7/16 | 36 | | 67 lb | 11.3 ft | GBS 3628 | ? | \$714 | |
| 27-3/4 | 13-7/16 | 42 | | 79 lb | 13.0 ft | GBS 4228 | ? | \$749 | |
| 39-7/8 | 13-7/16 | 30 | 3-high bookcase 2 adjustable shelves | 70 lb | 13.6 ft | GBS 3040 | ? | \$777 | |
| 39-7/8 | 13-7/16 | 36 | | 82 lb | 16.1 ft | GBS 3640 | ? | \$794 | |
| 39-7/8 | 13-7/16 | 42 | | 94 lb | 18.6 ft | GBS 4240 | ? | \$827 | |
| 51-3/8 | 13-7/16 | 30 | 4-high bookcase 3 adjustable shelves | 85 lb | 14.2 ft | GBS 3052 | ? | \$851 | |
| 51-3/8 | 13-7/16 | 36 | | 90 lb | 17.2 ft | GBS 3652 | ? | \$884 | |
| 51-3/8 | 13-7/16 | 42 | | 114 lb | 23.7 ft | GBS 4252 | ? | \$919 | |
| 65-7/8 | 13-7/16 | 30 | 5-high bookcase 4 adjustable shelves | 106 lb | 21.3 ft | GBS 3066 | ? | \$941 | |
| 65-7/8 | 13-7/16 | 36 | | 118 lb | 25.3 ft | GBS 3666 | ? | \$981 | |
| 65-7/8 | 13-7/16 | 42 | | 130 lb | 29.2 ft | GBS 4266 | ? | \$1,015 | |
| 77-3/8 | 13-7/16 | 30 | 6-high bookcase 5 adjustable shelves | 122 lb | 25.4 ft | GBS 3077 | ? | \$1,021 | |
| 77-3/8 | 13-7/16 | 36 | | 134 lb | 30.1 ft | GBS 3677 | ? | \$1,054 | |
| 77-3/8 | 13-7/16 | 42 | | 146 lb | 34.7 ft | GBS 4277 | ? | \$1,094 | |
| Additional Shelves | | | | Additional 30" shelf | 6 lb | 1.5 ft | BK 0700S | ? | \$80 |
| | | | | Additional 36" shelf | 7 lb | 1.5 ft | BK 0800S | ? | \$80 |
| | | | | Additional 42" shelf | 8 lb | 1.5 ft | BK 0900S | ? | \$80 |

Actual Outside Widths are:

- 30" = 29-11/16
- 36" = 35-11/16
- 42" = 41-11/16

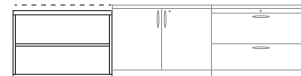

Note that the 2-high bookcase is slightly shorter than the 2-high lateral file and double door storage cabinet. The bookcase is designed to fit under a work surface.

| W | D | Description | Pkg Wt | Pkg Cube | Part # | Laminate | Price |
|----|---------|-------------------|--------|----------|--|----------|-------|
| 30 | 13-7/16 | Factory installed | 15 lb | .28 ft | Add laminate color as a suffix to the bookcase part number | ???? | \$325 |
| 36 | 13-7/16 | Factory installed | 17 lb | .30 ft | | ???? | \$345 |
| 42 | 13-7/16 | Factory installed | 19 lb | .40 ft | | ???? | \$390 |

| H | D | W | Description | Pkg Wt | Pkg Cube | Part # | Metal Color | Price |
|--------|--------|--------|--------------------|--------|----------|----------|-------------|-------|
| 26-1/2 | 15-1/4 | 32-1/2 | 1 adjustable shelf | 57 lb | 10.5 ft | MBC 2000 | ? | \$847 |

| H | D | W | Description | Pkg Wt | Pkg Cube | Part # | Price |
|---|---|-------|----------------|--------|----------|------------|-------|
| 8 | 3 | 7 1/2 | (package of 3) | 4.0 lb | 2 ft | LFM 300 30 | \$50 |

These conditions of sale supersede all previous selling policies. Prices, discounts, lead-times and product offerings are subject to change without notice.

Order Placement

Great Openings requires that all orders be submitted in writing to avoid errors and/or duplication. Sales of all Great Openings' products are made only on the Company's standard terms and conditions of sale, unless modified in writing by an authorized Great Openings representative.

Orders received at Great Openings after 4:00pm EST will be processed the following day.

Order Acknowledgement

We diligently issue order acknowledgements via e-mail within 24 hours of purchase order receipt. If you do not receive an acknowledgement within 24 hours, please call our Customer Service department to determine the reason; we may not have received your order, or we may have questions that are delaying order entry.

**PLEASE CHECK
ACKNOWLEDGEMENTS
FOR ERRORS
IMMEDIATELY UPON RECEIPT.**

The order acknowledgement process is designed to ensure protection for both the buyer and the seller. We strongly urge the buyer to make sure the acknowledgement accurately reflects the intended purchase.

Order Discrepancies

Great Openings will not be held responsible for extra costs due to errors resulting from purchase order inaccuracies. If and when a discrepancy is detected on the purchase order or acknowledgement, all corrections must be received in writing before further order processing can occur.

Changes, Cancellations

Orders may not be changed, corrected or cancelled, in whole or in part, after Great Openings has issued its order acknowledgement without the written consent of an authorized Great Openings representative. Special order items (special or custom cabinets, Customer's Own Materials (COM) fabric and laminates) already in production are not subject to change or cancellation under any circumstances.

Canadian Orders

Canadian orders may be processed using this price book. The pricing and payment terms included in this book are in U.S. funds. Custom brokerage fees and GST/HST taxes will be charged as separate line items on the invoice. All prices are freight included; FOB: Destination. A Regional Small Order Freight Charge applies to all orders less than \$5,000 list (does not apply to accessory orders). See regional map for applicable fee.

Lead-Time

Lead-times are measured in working days, and begin after receipt of clean order.

Lead-times may change without notice. Stated lead-times will not commence until purchase order is actually entered into our system. We are not responsible for delays caused by order discrepancies or late receipt of COM items.

Special Shipping Instructions

Great Openings will accommodate special shipping/delivery requests whenever possible. Purchaser will be responsible for any and all extra costs incurred by reason of Great Openings' complying with a special shipping request. Examples of special requests that may cause extra charges (dollar amounts shown are approximate, actual amounts may vary):

- special carrier/lift gate: starting at \$85.00
- inside delivery: starting at \$50.00
- expediting, re-consignment, delays causing carrier storage: starting at \$50.00
- truck load delivery times after 3:00 pm
- delivery times outside normal business hours including weekends and holidays: starting at \$450.00 per truck
- exact, narrow scheduling window (elevator time): starting at \$150.00
- non-commercial/residential deliveries: starting at \$60.00

The maximum amount of time allowed for off-loading product from trailers is 3 hours. Carrier costs associated with any additional delivery time will be charged to the dealer. Any additional charges that result from the purchaser failing to accept a shipment as agreed upon will be the responsibility of the purchaser.

Special Delivery Charges

Once a delivery truck arrives at a destination, if the recipient is not ready to accept delivery as scheduled and the truck must wait, deliver "after hours", or make a second drop at a later time, the carrier charges a penalty for that delay which Great Openings must pass on to the customer.

These charges are as follows (dollar amounts shown are approximate, actual amounts may vary):

Night Delivery:
3:30-4:30 p.m.: \$400 additional charge
4:30-5:30 p.m.: \$450 additional charge
5:30 p.m. and later: \$500 additional charge
Detention fee will be \$75 per hour after two hours. Drop charge will be \$75 per drop.

Weekend and holiday deliveries will be quoted per load depending on location and delivery time.

Please use caution when planning and communicating delivery requirements so that these exorbitant fees will not be necessary.

Key-Alike Services

Key-alike service is offered free of charge provided the key-alike request is associated with an order for a matching quantity of

cabinets. Additional key/core sets, master and core keys are available for a nominal charge. All Great Openings products are keyed randomly prior to shipment. Special cores and keys are shipped separately to be changed-out in the field. See the Specification Guide in the front of this book.

COM & Fabric Grades

If COM materials are difficult to apply or inadequate, Great Openings reserves the right to apply extra charges or to cancel the order. Great Openings has no control over COM material quality or performance and will not be held responsible for material defects or damage caused by improper use or application.

Lifetime Warranty

Great Openings warrants its filing and storage products to be free from defects in materials and workmanship for as long as the original purchaser owns the product. This warranty does not cover ordinary wear and tear, or improper installation or use of the product. This warranty does not apply to Customer's Own Materials (COM) for fabric, laminates, or edge bands.

In addition, supplier warranties will apply to products not manufactured by Great Openings. Please contact Great Openings for more information.

Credit Card Transaction Fee

Credit card payments in excess of the following thresholds will be subject to a 2.16% transaction fee. Please note that Great Openings also accepts payments via ACH, wire transfer, and check – all free of charge.

| Type of Sale | Credit Card Threshold (per sales order) | Fee Assessed for Amount Over this Threshold |
|-----------------------------|---|---|
| Commercial | \$10,000.00 | 2.16% |
| GSA: Project in USA | \$20,000.00 | 2.16% |
| GSA: Project outside of USA | \$30,000.00 | 2.16% |

Regional Pricing

Great Openings reserves the right to adopt regional discount programs and small order freight charges to address the freight cost impact applicable to each geographic region. A buyer's region will be determined by shipping destination.

Payment Terms

Orders are invoiced at the time of shipment and payment is due upon receipt of the invoice. Invoices unpaid thirty (30) days after the invoice date are subject to a late payment charge in the amount of one and one-half percent (1-1/2%) per month on the unpaid balance until paid. Great Openings reserves the right to modify or establish special credit arrangement for any customers at any time at its sole discretion. All prices are effective February 4, 2013, and are subject to change without notice.

Remit to:

**Great Openings
Dept. for Lockbox: 9521-11
PO Box 30516
Lansing, MI 48909-8016**

COMMERCIAL TERMS & CONDITIONS

Taxes

All sales, use, excise and other applicable taxes (excluding only taxes on the net income of Great Openings) are the purchaser's responsibility and will be invoiced to the purchaser. If purchaser claims an exemption from such taxes, it shall be the purchaser's responsibility to furnish an appropriate exemption certificate to Great Openings.

For Canadian orders, Great Openings does invoice and collect for GST/HST.

Freight Policy

All prices are freight included, F.O.B. Destination. Prices are based on a single shipment to a single location. A Small Order Freight Charge applies to all orders less than \$5,000 list (does not apply to orders for accessories).

See the map below for Small Order Freight Charge by destination. Effective March 1, 2017, orders totaling less than \$5,000 list that are shipped to Michigan, Wisconsin, Illinois, Indiana, Ohio, Kentucky, and West Virginia a Small Order Freight Charge of \$100 net will apply. For orders totaling less than \$5,000 list that are shipped to the remainder of the U.S., a Small Order Freight Charge of \$200 net will apply. For Alaska, Hawaii, and Canada, please call for a quote.

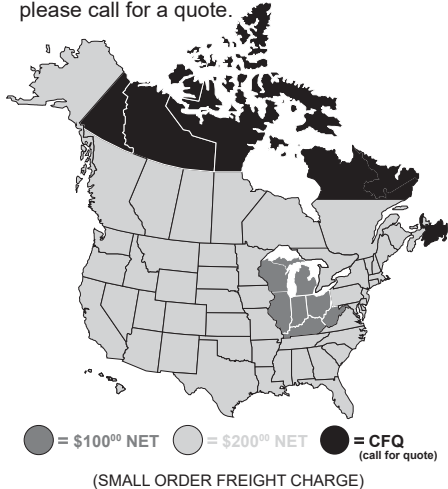

Standard Packaging

All Great Openings' products are packaged in accordance with industry standards and common carrier requirements. Pedestal products are individually boxed with polystyrene corner guard inserts, then palletized, and shrink wrapped. Lateral and storage product packaging consists of corrugated top and bottom trays, corner guards, palletized, shrink wrapped and labeled. For full truckloads only, upon special requests, we can provide a blanket wrapped shipment.

Shipment and Delivery

Freight is included in the prices as displayed in this price book. All shipments are FOB destination: free freight to destination in the continental United States. Shipments outside the contiguous 48 states will be freight collect from exit port. Exception for Canadian

shipments; see the section on Canadian orders. Great Openings will select the mode and carrier of shipment.

- Partial shipments may be necessary and are at the discretion of Great Openings.
- Great Openings cannot guarantee exact time of delivery.
- Any charges resulting from late deliveries beyond our control are not the responsibility of Great Openings.
- Ship dates contained in order acknowledgements are estimated and not guaranteed.

Great Openings will often consolidate orders to maximize shipping efficiency. In these situations, a customer's designated ship date may change, though Great Openings will make every effort to ensure that requested delivery dates are still met.

Product Storage Fees

Once an order enters production, it is not possible to stop production on that order if a last-minute request is made to delay shipment. If it is absolutely necessary to hold the product at Great Openings for a later ship date, a holding fee of \$7 net per pallet or \$100 net per trailer will be assessed each week and partial week until the product ships. Weekly storage fees will be the responsibility of the purchaser on any delayed shipment of a produced order.

Returns

Great Openings will not accept returned goods.

Claim Policy

It is the purchaser's responsibility to examine goods upon receipt and to notify Great Openings customer service with any concerns. Any claims against Great Openings for apparent defects, errors or shortages must be made by the purchaser within five (5) working days after any delivery. Failure by the purchaser to make any claim against Great Openings within (5) days shall constitute acceptance of the goods and waiver of any apparent defects, errors or shortages.

Freight Damage Claims

Great Openings' terms are FOB destination, Great Openings is not responsible for damage that occurs in transit. All Great Openings' products are carefully inspected prior to shipment. The carrier signs for all goods received in apparent good order.

It is the buyer's responsibility to inspect goods upon receipt for both apparent and concealed damage. In the rare instance where shipping damage is found, we ask the purchaser NOT to refuse shipment. Accepting shipment will give us more opportunities to remedy the situation through parts (fronts, tops) replacement and within the guidelines of the stated terms.

Claim and Replacement Policy

In the case of documented shipping damage, Great Openings will file a claim with the carrier and issue at no charge any replacement parts or product only if the purchaser meets the following conditions:

- Product is shipped via a Great Openings designated carrier
- Accept the shipment
- Retain packaging
- Inspect the shipment and document damage on the bill of lading
- Contact Great Openings immediately upon discovery and documentation of damage

Failure of purchaser to meet these conditions will prevent Great Openings from obtaining carrier reimbursement and thereby require us to charge full price for product replacement.

Great Openings is not responsible for labor or trip costs associated with freight damage product replacement.

Concealed Damage Policy

Concealed damage (damage discovered after acceptance with no bill of lading documentation) should be reported to Great Openings immediately upon discovery. Please retain packaging and request carrier inspection immediately. Carrier liability ceases 15 calendar days after receipt of shipment. Great Openings will investigate on a case-by-case basis. In any case, Great Openings assumes no liability beyond the 15-day carrier liability and reserves the right to apply no remedy and/or various remedies dictated by individual event circumstances.

The buyer may make NO DEDUCTION UNDER ANY CIRCUMSTANCES ensuing from freight claims when settling invoices with Great Openings.

Service

Please contact Great Openings with any service concerns:

Great Openings
902 E. Fourth Street
Ludington, MI 49431
Ph: 888-712-8582

- Metal filing, storage, and freestanding desk products
- Contract Number: GS-28F-0001S
- Current Contract Period: October 1, 2015- September 30, 2020
- Great Openings/Metalworks tax ID: 38 189 8020

- FSC Schedule 71, Part 1 - Office Furniture
- Special Item Numbers (SIN) 711-2, 711-3
- Small Business Set Aside
- Certified Small and Hub Zone Company

1a) Special Item Numbers Awarded:

- SIN 711-2 Work surfaces, Workstations, Computer Furniture and Accessories
- SIN 711-3 Filing and Storage Cabinets, Shelves, Mobile Carts, Dollies, Racks, and Accessories

1b) Lowest Priced Item:

- SIN 711-2 (2) Splice Plates and Fasteners GSP 02 K (\$40.00 list)
- SIN 711-3 6" Drawer Divider ECOX 1070- 1 (\$10.00 list)

2) Maximum Order:

- SIN 711-2 \$500,000 net
- SIN 711-3 \$500,000 net

3) Minimum Order:

- All SIN's \$50.00

4) Geographic Coverage:

All 48 contiguous states and the District of Columbia. Port of embarkation for delivery to Alaska, Hawaii, Puerto Rico, The Virgin Islands. U.S. Government installations overseas.

5) Point of Production:

Ludington, Michigan; Manistee, Michigan

6) Discount From List Prices

69.8%

7) Tier Discounts:

Tier discounts are available, call for details.

8) Prompt Payment Terms:

Net 30 Days

9a) Government Purchase Cards - Below Micro Threshold:

Visa and MasterCard accepted

9b) Government Purchase Cards - Above Micro Threshold:

Visa and MasterCard accepted

10) Foreign Items:

None (All products are manufactured, painted and assembled in U.S.)

11a) Time of Delivery:

Shipment: When applicable, within our standard lead-time, which is noted in the Commercial Terms and Conditions.
Delivery: 30 days after receipt of order.

11b) Expedited Delivery:

Considered on a case-by-case basis.
Call Great Openings for availability and cost.

11c) Overnight and Two-Day Delivery:

Considered on a case-by-case basis.
Call Great Openings for availability and cost.

11d) Urgent Requirements:

Considered on a case-by-case basis.
Call Great Openings for availability and cost.

12) F.O.B. Destination, Freight Prepaid and Allowed:

48 Contiguous States and Washington D.C.

For orders totaling less than \$1,000 net that are shipped to the western U.S. (including Montana, Wyoming, Colorado, New Mexico, Texas and all states west), the state of Florida, and New York City (including the Bronx, Brooklyn, Manhattan, Queens, and Staten Island), a Small Order Handling Fee of \$100 will apply. For orders totaling less than \$1,000 net that are shipped to the remainder of the U.S., a Small Order Handling Fee of \$50 will apply.

13a) Ordering Address:

Great Openings
902 E. Fourth Street
Ludington, Michigan 49431
Phone 888-712-8582
Fax 231-843-6373
www.greatopenings.com

13b) Ordering Procedures:

For supplies and services, the ordering procedures, information on Blanket Purchase Agreements (BPA's), and a sample BPA can be found in Federal Acquisition Regular (FAR) 8.405-3.

14) Payment Address:

Great Openings
P.O. Box 910
Traverse City, MI 49685-0910

15) Warranty Provision:

Lifetime Warranty
See warranty section for complete details in the Commercial Terms and Conditions.

16) Export Packaging Charges:

Quoted upon request

17) Terms And Condition of Government Purchase Card:

See item 9a + 9b. No additional discounts given.

18) Terms and Conditions of Rental, Maintenance and repair:

Not Applicable

19) Terms and Conditions of Installation:

Contact dealer or installation representative.

20) Terms and Conditions of Repair Parts:

Not Applicable

20a) Terms and Conditions for Any Other Services:

Not applicable

21) List of Service and Distribution Points:

Not Applicable

22) List of Dealers:

Please contact Great Openings for your nearest Great Openings Dealer.

23) Preventative Maintenance:

Not offered

24a) Environmental Attributes:

Has an active environmental program. Please contact Great Openings Dealer.

24b) Section 508 Electronic Compliance:

Currently not available

25) DUNS Number:

00-495-0549

26) CCR:

Great Openings is registered with the Central Contractor Registration (CCR) database. Cage Code: 33LN6

Cancellation Policy:

Orders may not be cancelled or changed without approval from Great Openings. If an order is cancelled prior to production, no cancellation charge will apply.

After production has begun, the Government will pay actual costs that the contractor can demonstrate if the product is not sold in a reasonable length of time (3 months).

Returns / Restocking Charge:

The Government will pay a 33% restocking charge.

The customer agency must obtain written authorization from Great Openings before returning any product. The customer agency will pay all return freight charges. Product returned in damaged condition will not be accepted.

DOD Requirements for Wood Packaging:

DOD's requirements (ISPM 15) for wood packaging material (WPM) are designed to block the movement of forest-destroying pests from one nation to another. Please clearly mark DOD-related purchase orders so that the required packaging can be included.



902 East 4th Street
Ludington, MI 49431
Telephone: 888-712-8582
Fax: 231-843-6373
Web: www.greatopenings.com
E-mail: greatopeningscust.serv@greatopenings.com